



# SINOPULSE HOSE FACTORY CO.,LTD

## HYDRAULIC HOSE & FITTING



SINOPULSE HOSE FACTORY CO.,LTD

Add: South Of Xingfu Road, Feixiang Industrial Zone, Handan City, Hebei Province, China.

Tel: +86-311-87162169; Fax: +86-311-87663100

Web: [www.sinopulse.cn](http://www.sinopulse.cn)

Email: [sales@sinopulse.cn](mailto:sales@sinopulse.cn)



## Who Are SINOPULSE

- ★ Sinopulse is a 100% manufacturer for hydraulic hoses, Industrial rubber hose include all oilfield, agriculture, transportation, construction, mining and forestry.
- ★ Daily output 100,000 Meters hoses, covering 20,000 m<sup>2</sup>.
- ★ 20 Production lines, involving high speed joint machines, Braiding Machines, High speed Spiral machines, Italy VP automatic industrial machines and full series Laboratory Testing Equipments
- ★ 120 Skilled workers, 6 Engineers with 2 technical counselors from international famous companies, 2 QC Managers and 2 Warehouse Managers are all of our lovely people.
- ★ 30 Sales and 3 groups logistics specialists serve our customers from Italy, Germany, UK, Spain, USA, Canada, Brazil, Argentina, Panama, Peru, Chile, Vietnam, Indonesia, Australia...



# QUALITY MAKES DIFFERENCE

## Why Choose Us ?

- ✓ 15 Years experience and ISO 9001:2008 Certificated Manufacturer
- ✓ Laboratory test give us TOP quality raw materials:
  - Steel wire/Rubber Material strength testing;
  - Rubber and steel wire adhensive testing;
  - Rubber aging testing;
- ✓ Responsibility card supervise every step during production;
- ✓ Strict Quality Control institution after production;
  - Hose burst pressure testing;
  - Hose Impulse test.
- ✓ Fast, Friendly, Knowledgeable sales & sales professional with Extended Business Hours & 24/7 Emergency Service offer all hoses, fittings, and related accessories;
- ✓ After-Sale service guarantee & warranty.
- ✓ OEM Brand service is available .



WWW.SINOPULSE.CN

Tel: 0086(311)87162169

Fax: 0086(311)87663100



邯郸市斯诺普胶管有限公司  
Handan Sinopulse Hose Co., Ltd.

Materials laboratory testing



Hose Impulse test

High speed joint machines



Braiding machines

SINOPULSE Warehouse



Plastic hose reel



斯诺普  
SINOPULSE<sup>®</sup>



Hose Breaking test



High speed spiral machine



SINOPULSE Workshop

◎SINOPULSE stays ahead of manufacturing equipment, system and people.  
◎Rigorous laboratory testing system give us confidence on the quality.  
◎We can offer complete Hydraulic hoses, industrial hoses and related accessories solution















Hose  
 Ferrule  
 Fitting JIC  
 Fitting ORFS  
 Fitting NPT  
 Fitting SAE  
 Fitting BSP  
 Fitting Flange  
 Fitting Metric  
 Fitting JIS  
 Adapter  
 Quick Coupling  
 Camlock  
 Hose Clamp  
 Machine

Hose  
 Ferrule  
 Fitting JIC  
 Fitting ORFS  
 Fitting NPT  
 Fitting SAE  
 Fitting BSP  
 Fitting Flange  
 Fitting Metric  
 Fitting JIS  
 Adapter  
 Quick Coupling  
 Camlock  
 Hose Clamp  
 Machine

### Air/Water Suction and Discharge hose



1. Tube: Black NR/BR rubber;
2. Reinforcement: Multiple textile cords & Steel Spiral;
3. Cover: Black NR/SBR rubber;
4. Application: Suction and Discharge the Water / Air/ Oil, and petroleum products up to 50% aromatics;
5. Safety: 3:1
6. Temperature Range: -20°C to 100°C

Hose Type	I.D.		Low Pressure			High pressure			Length
			Layer	W.P	O.D	Layer	W.P	O.D	
Dash	Inch	mm		Bar			Bar	mm	M/Roll
-12	3/4"	19.0	2	10	31	4	20	33	60
-16	1"	25.4	2	10	37	4	20	39	60
-20	1.1/4"	31.8	2	10	45	4	20	48	60
-24	1.1/2"	38.2	2	10	52	4	20	54	60
-28	1.3/4"	45.0	2	10	59	4	20	62	60
-32	2"	50.8	4	10	65	4	20	71	60
-40	2.1/2"	64.0	4	10	80	4	20	83	60
-48	3"	76.0	4	10	92	4	20	95	60
-56	3.1/2"	89.0	4	10	107	6	20	112	60
-64	4"	102.0	4	10	120	6	20	125	60
-80	5"	127.0	4	10	147	6	20	155	30
-72	6"	152.0	4	10	172	6	20	180	30
-128	8"	203.0	6	10	229	6	20	235	10
-160	10"	254.0	4	10	282	6	20	288	10
-192	12"	300.0	4	10	329	8	20	340	10

### Fuel Oil Suction and Discharge hose



1. Tube: Black NR/BR rubber;
2. Reinforcement: Multiple textile cords & Steel Spiral;
3. Cover: Black NR/SBR rubber;
4. Application: Suction and Discharge the Water / Air/ Oil, and petroleum products up to 50% aromatics;
5. Safety: 3:1
6. Temperature Range: -20°C to 100°C

Hose Type	I.D.		Low Pressure			High pressure			Length
			Layer	W.P	O.D	Layer	W.P	O.D	
Dash	Inch	mm		Bar			Bar	mm	M/Roll
-12	3/4"	19.0	2	10	31	4	20	33	60
-16	1"	25.4	2	10	37	4	20	39	60
-20	1.1/4"	31.8	2	10	45	4	20	48	60
-24	1.1/2"	38.2	2	10	52	4	20	54	60
-28	1.3/4"	45.0	2	10	59	4	20	62	60
-32	2"	50.8	4	10	65	4	20	71	60
-40	2.1/2"	64.0	4	10	80	4	20	83	60
-48	3"	76.0	4	10	92	4	20	95	60
-56	3.1/2"	89.0	4	10	107	6	20	112	60
-64	4"	102.0	4	10	120	6	20	125	60
-80	5"	127.0	4	10	147	6	20	155	30
-72	6"	152.0	4	10	172	6	20	180	30
-128	8"	203.0	6	10	229	6	20	235	10
-160	10"	254.0	4	10	282	6	20	288	10
-192	12"	300.0	4	10	329	8	20	340	10

### Sandblasting Hose



1. Tube: Black NR/BR rubber;
2. Reinforcement: Multiple textile cords;
3. Cover: Black NR/SBR rubber;
4. Application: Transportation of quartz, metal sand, polishing, metal surface rust and spray cement, anti-static;
5. Safety: 3:1
6. Temperature Range: -20°C to 100°C

Hose	I.D.		W.P	O.D.	Layer	W.P	O.D.	Layer	Length
Dash	Inch	mm	Bar	mm		Bar	mm		M/Roll
-12	3/4"	19.1	12	33.0	2	20	34	4	60
-16	1"	25.4	12	39.0	2	20	41	4	60
-20	1.1/4"	31.8	12	48.0	2	20	50	4	60
-24	1.1/2"	38.1	12	55.0	2	20	57	4	60
-32	2"	50.8	12	68.5	2	20	73	6	60
-40	2.1/2"	63.5	12	84.0	4	20	84	4	60
-48	3	76.2	12	97.0	4	20	101	6	60
-64	4"	102.0	12	124.0	4	20	127	6	60
-80	5"	127.0	12	149.0	4	20	156	8	60
-96	6"	152.0	12	177.0	4				60
-128	8"	203.0	12	228.0	4				60



### Tank Truck Hose



Hose Type	I.D.		O.D.	W.P		B.P		B.R	W.T
Dash	Inch	mm	mm	Bar	PSI	Bar	PSI	M	kg/m
-32	2"	51.0	65.0	15	250	45	750	0.33	1.81
-40	2.1/2"	63.0	80.0	15	250	45	750	0.4	2.78
-48	3"	76.0	93.0	15	250	45	750	0.5	2.93
-64	4"	102.0	120.0	15	250	45	750	0.73	4.95
-80	5"	127.0	149.0	15	250	45	750	0.9	6.6
-96	6"	152.0	174.0	15	250	45	750	1.01	7.8

1. Tube: Fule oil resistant rubber;
2. Reinforcement: High tensile textile with helix steel wire with cooper wire;
3. Cover: high tensile synthetic rubber;
4. Application: for tank truck, delivery the petroleum products up to 50% aromatic content,
5. Safety: 3:1
6. Temperature Range: -40°C to 100°C

### Concrete Plaster Hose



Hose Type	I.D.		O.D.	W.P		B.P		Length	W.T
Dash	Inch	mm	mm	Bar	PSI	Bar	PSI	M	kg/m
-16	1"	25.4	45.0	55	800	165	2400	60	1.48
-20	1.1/4"	31.8	51.0	55	800	165	2400	60	1.71
-24	1.1/2"	38.1	57.5	55	800	165	2400	60	1.94
-32	2"	50.8	74.0	55	800	165	2400	60	3.02
-40	2.1/2"	63.5	87.0	55	800	165	2400	60	3.58
-48	3"	76.2	100.0	38	550	114	1650	60	4.13
-64	4"	101.6	132.0	38	550	114	1650	60	6.95
-80	5"	127.0	157.0	38	550	114	1650	60	8.39
-96	6"	152.4	186.0	38	550	114	1650	60	11.15
-128	8"	203.2	243.0	38	550	114	1650	40	15

1. Tube: Black NR/BR rubber;
2. Reinforcement: Multiple textile cords & Steel Spiral;
3. Cover: Black NR/SBR rubber;
4. Application: Transmission concrete, Grouting;
5. Safety: 3:1
6. Temperature Range: -20°C to 80°C

### Dry Cement Hose



Hose Type	I.D.		O.D.	W.P		B.P		Length	W.T
Dash	Inch	mm	mm	Bar	PSI	MPa	PSI	M	kg/m
-48	3"	76.0	96.0	10	150	30	450	20	3.81
-64	4"	102.0	124.0	10	150	30	450	20	5.47
-80	5"	127.0	150.0	10	150	30	450	20	6.99
-96	6"	152.0	175.0	10	150	30	450	10	8.21
-128	8"	203.0	238.0	10	150	30	450	10	16.33

1. Tube: Black NR/BR rubber;
2. Reinforcement: Multiple textile cords & Steel Spiral;
3. Cover: Black NR/SBR rubber;
4. Application: Transfer dry materials, dry cement ,pebble line, abrasive material
5. Safety: 3:1
6. Temperature Range: -20°C to 80°C

### Jack hammer hose



Hose Type	I.D.		O.D.	W.P		B.P	
Dash	Inch	mm	mm	Bar	PSI	Bar	PSI
-12	3/4"	19.1	30.0	20	300	60	900
-16	1"	25.4	36.0	20	300	60	900



Hose  
 Ferrule  
 Fitting JIC  
 Fitting ORFS  
 Fitting NPT  
 Fitting SAE  
 Fitting BSP  
 Fitting Flange  
 Fitting Metric  
 Fitting JIS  
 Adapter  
 Quick Coupling  
 Camlock  
 Hose Clamp  
 Machine

**DOCK/CARGO/MARINE OIL HOSE**

Heavy Duty suction and discharge hose designed specially for transferring petroleum production for tankers, barges and storage tanks

\*Exclusive construction allows for excellent flexibility

\*Specially formulated tube is resistant up to 50% aromatics

\*Rugged cover is resistant to oil, cuts, scuffs, and ozone attack.



Hose Type	I.D.		W.P	Length
	Inch	MM		
No.	Inch	MM	Bar	M/PCS
1	6	150.0	10-20Bar	11.8M
2	8	200.0	10-20Bar	11.8M
3	10	250.0	10-20Bar	11.8M
4	12	300.0	10-20Bar	11.8M
5	16	400.0	10-20Bar	11.8M
6	20	500.0	10-20Bar	11.8M

1. Tube: NBR compound synthetic rubber
2. Reinforcement: High tensile strength fabrics with helix steel wire
3. Cover: chloroprene synthetic rubber.
4. Safety: 5:1
5. Safety: 5:1
6. Temperature Range: -25°C to 100°C

**DISCHARGE DREDGE HOSE**

Used for port, dock, discharge seawater, silt, sand, flood, etc. Particularly suited to the work of dredging construction for dock and port, building project and so on. The suction hose has good stiffness can not appear abnormal abrasion, partial arch and eddy of some part place of inner rubber that is formed by the bend which is caused by storm and tide.



Hose Type	I.D.		W.P	B.P.	Length	Wall thickness
	Inch	Tolerance				
No.	Inch	Tolerance	Bar	Bar	M/PCS	mm
1	300	±2	4-12Bar	36	1-3	35
2	450	±2	4-12Bar	36	1-3	36
3	560	±3	4-12Bar	36	2-3	42
4	600	±3	4-12Bar	36	2-3	42
5	700	±3	8-15Bar	45	2-3	42
6	800	±4	12-25Bar	55	2-3	51
7	900	±4	15-25Bar	75	2-3	56
8	1000	±5	20-25Bar	75	3-5	75
9	1100	±5	25-30Bar	80	3-5	90

1. Tube: NR/BR and SBR compound synthetic rubber
2. Reinforcement: High tensile strength fabrics with helix steel wire
3. Cover: chloroprene synthetic rubber and NR
4. Safety: 5:1
5. Safety: 5:1
6. Temperature Range: -25°C to 70°C

**SLURRY SUCTION HOSE**



Hose Type	I.D.		W.P	Length
	Inch	mm		
No.	Inch	mm	Bar	M/PCS
1	8"	200	15-20Bar	11.8M
2	10"	250	15-20Bar	11.8M
3	12"	300	15-20Bar	11.8M
4	16"	400	15-20Bar	11.8M
5	20"	500	15-20Bar	11.8M
6	24"	600	15-20Bar	11.8M
7	26"	650	15-20Bar	11.8M
8	30"	750	15-20Bar	11.8M
9	32"	800	15-20Bar	11.8M
10	34"	850	15-20Bar	11.8M

1. Tube: NR/BR and SBR compound synthetic rubber
2. Reinforcement: High tensile strength fabrics with Steel Rings;
3. Cover: chloroprene synthetic rubber and NR
4. Safety: 3:1
5. Safety: 3:1
6. Temperature Range: -25°C to 80°C

Installed between the pump and cutter of the dredger, suction the slurry. Suction hose & armored hose with HB steel ring in, suitable for limestone, granite, coral and mineral, ect.

**UHMW PE Chemical hose**



Hose Type	I.D.		O.D.	W.P		B.P		B.R	W.T
	Inch	mm		Bar	PSI	MPa	PSI	M	kg/m
Dash	Inch	mm	mm	Bar	PSI	MPa	PSI	M	kg/m
-16	1"	25.0	38.0	10	150	30	450	0.254	0.93
-20	1.1/4"	32.0	45.0	10	150	30	450	0.33	1.25
-24	1.1/2"	38.0	51.0	10	150	30	450	0.381	1.47
-32	2"	50.0	64.0	10	150	30	450	0.508	1.92
-40	2.1/2"	64.0	78.0	10	150	30	450	0.635	2.51
-48	3"	76.0	89.0	10	150	30	450	0.762	2.9
-64	4"	102.0	118.0	10	150	30	450	1.01	3.92
-80	5"	125.0	145.0	10	150	30	450	1.27	6.99
-96	6"	152.0	174.0	10	150	30	450	1.52	8.99

1. Tube: UHMWPE;
2. Reinforcement: High tensile textile with helix steel wire;
3. Cover: EPDM synthetic rubber;
4. Application: Transportation of 98% of all chemicals, solvents and corrosive liquid in both pressure and suction service ;
5. Safety: 3:1
6. Temperature Range: -40°C to 120°C



Hose Type	I.D.		O.D.	W.P		B.P		B.R	W.T
	Inch	mm		Bar	PSI	MPa	PSI	M	kg/m
Dash	Inch	mm	mm	Bar	PSI	MPa	PSI	M	kg/m
-16	1"	25.0	38.0	10	150	30	450	0.254	0.93
-20	1.1/4"	32.0	45.0	10	150	30	450	0.33	1.25
-24	1.1/2"	38.0	51.0	10	150	30	450	0.381	1.47
-32	2"	50.0	64.0	10	150	30	450	0.508	1.92
-40	2.1/2"	64.0	78.0	10	150	30	450	0.635	2.51
-48	3"	76.0	89.0	10	150	30	450	0.762	2.9
-64	4"	102.0	118.0	10	150	30	450	1.01	3.92
-80	5"	125.0	145.0	10	150	30	450	1.27	6.99
-96	6"	152.0	174.0	10	150	30	450	1.52	8.99

**UHMW PE Food hose**



1. Tube: UHMWPE;
2. Reinforcement: High tensile textile with helix steel wire;
3. Cover: EPDM synthetic rubber;
4. Application: Transportation food, potable water, animal tallow and edible oil;
5. Safety: 3:1
6. Temperature Range: -40°C to 120°C

**Liquid Petroleum Gas / Natural Gas hose**



Hose Type	I.D.		O.D.	W.P		B.P		B.R	W.T
	Inch	mm		Bar	PSI	MPa	PSI	M	kg/m
Dash	Inch	mm	mm	Bar	PSI	MPa	PSI	M	kg/m
-16	1"	25.0	38.0	10	150	30	450	0.254	0.93
-20	1.1/4"	32.0	45.0	10	150	30	450	0.33	1.25
-24	1.1/2"	38.0	51.0	10	150	30	450	0.381	1.47
-32	2"	50.0	64.0	10	150	30	450	0.508	1.92
-40	2.1/2"	64.0	78.0	10	150	30	450	0.635	2.51
-48	3"	76.0	89.0	10	150	30	450	0.762	2.9
-64	4"	102.0	118.0	10	150	30	450	1.01	3.92
-80	5"	125.0	145.0	10	150	30	450	1.27	6.99
-96	6"	152.0	174.0	10	150	30	450	1.52	8.99

1. Tube: Smooth UHMWPE and EPDM Synthetic rubber;
2. Reinforcement: High tensile textile cord with helix steel wire and conductive copper wire;
3. Cover: Abrasion, weather resistant rubber;
4. Application: Transportation liquefied petroleum gas and liquefied natural gas.
5. Safety: 3:1
6. Temperature Range: -40°C to 120°C



Hose  
 Ferrule  
 Fitting JIC  
 Fitting ORFS  
 Fitting NPT  
 Fitting SAE  
 Fitting BSP  
 Fitting Flange  
 Fitting Metric  
 Fitting JIS  
 Adapter  
 Quick Coupling  
 Camlock  
 Hose Clamp  
 Machine

# HOW TO ORDER FITTING

## 1. PART NUMBER

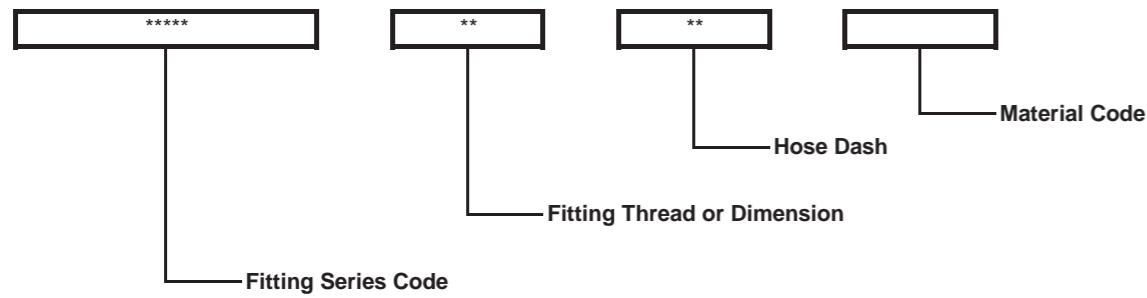

## 2. MATERIAL CODE

Material	Carbon Steel	Copper	Stainless Steel
Sign	\	BR	SS

## 3. HOSE CODE

Hose DN	5	6	8	10	12	16	20	22	25	32	40	50	64
Hose Dash	-3	-4	-5	-6	-8	-10	-12	-14	-16	-20	-24	-32	-40

## 4. SIZE CODE TABLE

Size		Thread Size Or O.D. * Of Thread per Inch						
Dash	Inch	BSPF	BSPT	NPT	JIC	SAE	ORFS	FLANGE
-02	1/8"	G1/8**28	R1/8**28	Z1/8**27	5/16**24	5/16**24	\	\
-03	3/16"	\	\	\	3/8**24	3/8**24	\	\
-04	1/4"	G1/4**19	R1/4**19	Z1/4**18	7/16**20	7/16**20	9/16**18	\
-05	5/16"	\	\	\	1/2**20	1/2**20	\	\
-06	3/8"	G3/8**19	R3/8**19	Z3/8**18	9/16**18	9/16**18	11/16**16	\
-08	1/2"	G1/2**14	R1/2**14	Z1/2**14	3/4**16	3/4**16	13/16**16	1/2"
-10	5/8"	G5/8**14	\	\	7/8**14	7/8**14	1**14	\
-12	3/4"	G3/4**14	R3/4**14	Z3/4**14	1.1/16**12	1.1/16**12	1.3/16**12	3/4"
-14	7/8"	\	\	\	1.3/16**12	1.3/16**12	1.5/16**12	\
-16	1"	G1**11	R1**11	Z1**11.5	1.5/16**12	1.5/16**12	1.7/16**12	1"
-20	1.1/4"	G1.1/4**11	R1.1/4**11	Z1.1/4**11.5	1.5/8**12	1.5/8**12	1.11/16**12	1.1/4"
-24	1.1/2"	G1.1/2**11	R1.1/2**11	Z1.1/2**11.5	1.7/8**12	1.7/8**12	2**12	1.1/2"
-32	2"	G2**11	R2**11	Z2**11.5	2.1/2**12	2.1/2**12	2.1/2**12	2"

NOTE: The Dash Of Metric Thread Accords With O.D. Of Thread.



Hose  
 Ferrule  
 Fitting JIC  
 Fitting ORFS  
 Fitting NPT  
 Fitting SAE  
 Fitting BSP  
 Fitting Flange  
 Fitting Metric  
 Fitting JIS  
 Adapter  
 Quick Coupling  
 Camlock  
 Hose Clamp  
 Machine

Non-Skive ferrule for 1SN/R1AT-00110

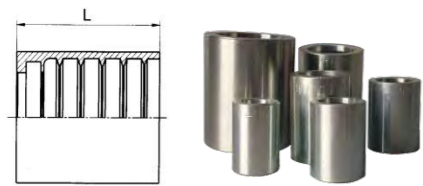

Part No.	DN	L
00110-03	5	23
00110-04	6	30.5
00110-05	8	30
00110-06	10	32
00110-08	12	34
00110-10	16	37
00110-12	20	42
00110-16	25	51
00110-20	32	59
00110-24	40	74
00110-32	51	78

Skive Ferrule for 1SN/R1AT -00100

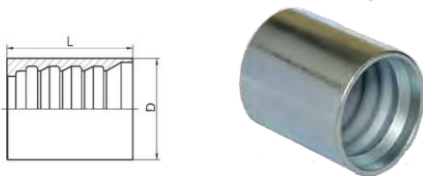

Part No.	DN	L
00100-03	5	23
00100-04	6	30
00100-05	8	31
00100-06	10	32
00100-08	12	34
00100-10	16	37
00100-12	20	43
00100-16	25	50
00100-20	32	59
00100-24	40	74
00100-32	51	78

Multipurpose Ferrule for 1SN/2SN - 03310

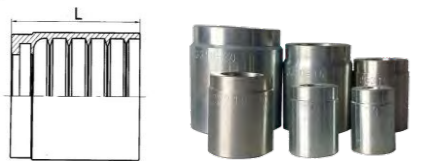

Part No.	DN	L
03310-03	5	23
03310-04	6	30.5
03310-05	8	31
03310-06	10	32
03310-08	12	34
03310-10	16	37
03310-12	20	43
03310-16	25	51
03310-20	32	57
03310-24	40	60
03310-32	51	75

Non-Skive ferrule for 2SN/R2AT-00210

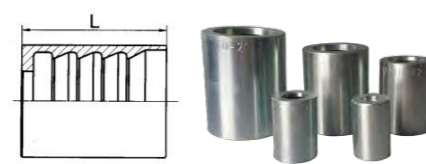

Part No.	DN	L
00210-03	5	27
00210-04	6	30
00210-05	8	31
00210-06	10	32
00210-08	12	34
00210-10	16	37
00210-12	20	43
00210-16	25	50
00210-20	32	59
00210-24	40	74
00210-32	51	78

Skive Ferrule for 2SN/2AT - 00200

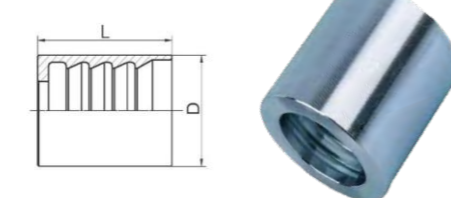

Part No.	DN	L
00200-03	5	27
00200-04	6	30
00200-05	8	31
00200-06	10	32
00200-08	12	34
00200-10	16	37
00200-12	20	43
00200-16	25	50
00200-20	32	59
00200-24	40	70
00200-32	51	78

Skive Ferrule for 4SP/4SH/12-16; R12/06-16 -00400



Part No.	DN	L
00400-04	6	37.5
00400-06	10	39
00400-08	12	41
00400-10	16	43
00400-12	20	51
00400-16	25	61.5
00400-20	32	67.5
00400-24	40	75
00400-32	51	79

Non-Skive Ferrule for 4SH;R12/32 00401

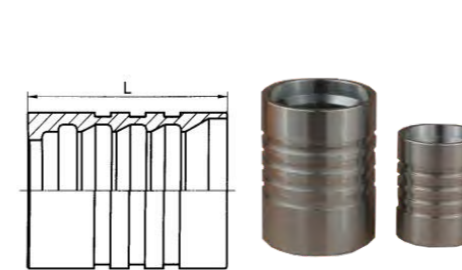

Part No.	DN	L
00401-20	32	59
00401-24	40	74
00401-32	51	78

Non-Skive Ferrule for R12/4SP/04-16-00402



Part No.	DN	L
00402-04	6	30
00402-06	10	33
00402-08	12	34
00402-10	16	39
00402-12	20	40
00402-16	25	51
00402-20	32	60
00402-24	40	70
00402-32	50	72

Ferrule for R7/R8 - 00018

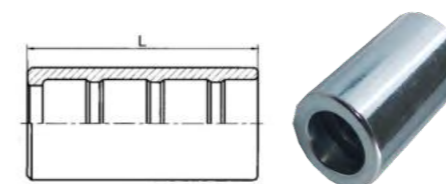

Part No.	DN	L
00018-03	5	27
00018-04	6	29
00018-05	8	31
00018-06	10	31
00018-08	12	34
00018-10	16	36
00018-12	20	43

Skive inner & outer rubber Ferrule for 4SH -000421

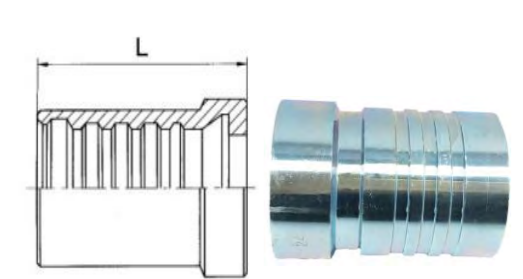

Part No.	DN	L
00421-20	32	88
00421-24	40	102
00421-32	50	108

Ferrule for Teflon hose - 00TFO

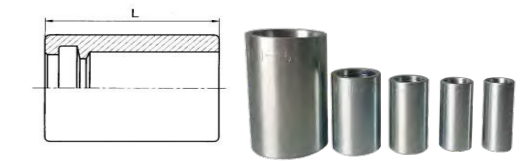

Part No.	DN	L
00TF0-03	5	27.5
00TF0-04	6	30.7
00TF0-05	8	30.6
00TF0-06	10	32.1
00TF0-08	12	34.3
00TF0-10	16	37
00TF0-12	20	42.8
00TF0-14	22	42.7
00TF0-16	25	50.8

Interlock ferrule for hoses - 00621



Part No.	DN	L
00621-12	20	53
00621-16	25	66
00621-20	32	88.5
00621-24	40	102
00621-32	51	108

Hose  
 Ferrule  
 Fitting JIC  
 Fitting ORFS  
 Fitting NPT  
 Fitting SAE  
 Fitting BSP  
 Fitting Flange  
 Fitting Metric  
 Fitting JIS  
 Adapter  
 Quick Coupling  
 Camlock  
 Hose Clamp  
 Machine

Hose  
 Ferrule  
 Fitting JIC  
 Fitting ORFS  
 Fitting NPT  
 Fitting SAE  
 Fitting BSP  
 Fitting Flange  
 Fitting Metric  
 Fitting JIS  
 Adapter  
 Quick Coupling  
 Camlock  
 Hose Clamp  
 Machine

**JIC MALE 74 °Cone / ISO 8434-2 / SAE J514-16711**

Part No.	Thread	DN	A	C	S1
16711-04-04	7/16**20	6	26.5	14	12
16711-05-05	1/2**20	8	26.5	14	14
16711-06-06	9/16**18	10	26.5	14.1	17
16711-08-08	3/4**16	12	32	16.7	22
16711-10-10	7/8**14	16	35.5	19.3	24
16711-12-12	1.1/16**12	20	40	21.9	27
16711-16-16	1.5/16**12	25	43.5	23.1	36
16711-20-20	1.5/8**12	32	47.5	24.3	46
16711-24-24	1.7/8**12	40	53	27.5	50
16711-32-32	2.1/2**12	50	62	33.9	65

Material: Carbon steel #45 / Stainless steel  
 Application: Used for 1SN/2SN hose.  
 Spiral hose fitting: 16712  
 One piece fitting: 16711F

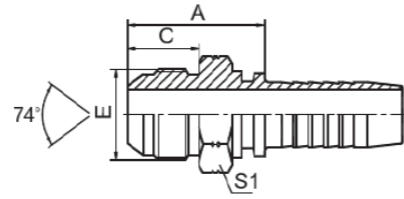

**JIC MALE 74 °Cone / ISO 8434-2 / SAE J514-16718**

Part No.	Thread	DN	A	S1
16718-04-04(R5)	7/16**20	6	29	12
16718-06-05(R5)	9/16**18	8	31	17
16718-06-06(R5)	9/16**18	10	32	17
16718-08-06(R5)	3/4**16	10	34.7	22
16718-08-08(R5)	3/4**16	12	38	22
16718-10-10(R5)	7/8**14	16	40.5	24
16718-12-12(R5)	1.1/16**12	20	45.5	30
16718-16-16(R5)	1.5/16**12	25	44	36
16718-20-20(R5)	1.5/8**12	32	49.5	46
16718-24-24(R5)	1.7/8**12	40	52.5	50

Material: Carbon steel #45 / Stainless steel  
 Application: Used for R5 hose.

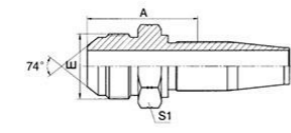

**JIC FEMALE 74 °Cone SAET / SAE J514-26711**

Part No.	Thread	DN	A	C	S2
26711-04-04	7/16**20	6	15	9	15
26711-05-05	1/2**20	8	15.5	9.5	17
26711-06-06	9/16**18	10	15.5	10.5	19
26711-08-08	3/4**16	12	18	11	24
26711-10-10	7/8**14	16	20	13	27
26711-12-12	1.1/16**12	20	21.5	15	32
26711-16-16	1.5/16**12	25	23	16	41
26711-20-20	1.5/8**12	32	26	17	50
26711-24-24	1.7/8**12	40	26.5	20	55
26711-32-32	2.1/2**12	50	27	23.5	75

Material: Carbon steel #45 / Stainless steel  
 Application: Used for 1SN/2SN hose.  
 T type fitting: 26711T  
 Spiral hose fitting: 26712

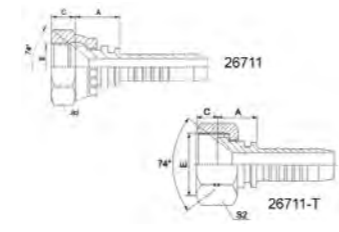

**JIC FEMALE 74 °Cone SAET Double Hexagon / SAE J514 - 26711D**

Part No.	Thread	DN	A	C	S1	S2
26711D-04-04	7/16**20	6	20	9	15	15
26711D-05-04	1/2**20	6	20.5	9.5	17	17
26711D-06-04	9/16**18	6	21	10.5	19	19
26711D-06-06	9/16**18	10	21	10.5	19	19
26711D-08-06	3/4**16	10	25	11	24	24
26711D-08-08	3/4**16	12	24.5	11	24	24
26711D-10-08	7/8**14	12	28	13	27	27
26711D-10-10	7/8**14	16	29	13	27	27
26711D-12-12	1.1/16**12	20	31.5	15	32	32
26711D-16-12	1.5/16**12	20	33.5	16	41	41
26711D-16-16	1.5/16**12	25	34.5	16	41	41
26711D-20-20	1.7/16**12	32	39	17	50	50

Material: Carbon steel #45 / Stainless steel  
 Application: Used for 1SN/2SN hose.  
 Spiral hose fitting: 26712D

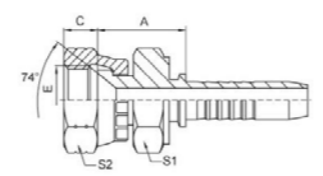

**45° JIC FEMALE 74 °Cone SAET Double Hexagon / SAE J514 - 26711DSM**

Part No.	Thread	DN	A	C	S1	S2
26711D-04-04-SM	7/16**20	6	20	9	12	15
26711D-05-04-SM	1/2**20	6	20.5	9.5	12	17
26711D-06-04-SM	9/16**18	6	21	10.5	14	19
26711D-06-06-SM	9/16**18	10	21	10.5	17	19
26711D-08-08-SM	3/4**16	12	24.5	11	22	24
26711D-10-10-SM	7/8**14	12	24	13	22	27
26711D-10-10-SM	7/8**14	16	27	13	22	27
26711D-12-12-SM	1.1/16**12	20	31.5	15	27	32
26711D-16-16-SM	1.5/16**12	25	32.5	16	32	41
26711D-20-20-SM	1.7/16**12	32	37	17	41	50

Material: Carbon steel #45 / Stainless steel  
 Application: Used for 1SN/2SN hose.  
 Spiral hose fitting: 26712D

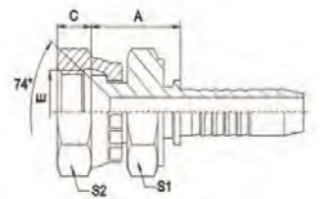

**One piece fitting - JIC FEMALE 74 °Cone SAET / SAE J514 - 26711F**

Part No.	Thread	DN	C	S1	S2
26711F-04-04B	7/16**20	6	9	17	17
26711F-06-06B	9/16**18	10	10	19	19
26711F-08-08B	3/4**16	12	11	24	22
26711F-10-10B	7/8**14	16	12	27	27
26711F-12-12B	1.1/16**12	20	13	32	32
26711F-16-16B	1.5/16**12	25	14	38	38
26711F-20-20B	1.5/8**12	32	15	50	50
26711F-24-24B	1.7/8**12	40	19	55	55

Material: Carbon steel #45 / Stainless steel  
 Application: Used for 1SN/2SN hose.  
 Spiral hose fitting: 26712F

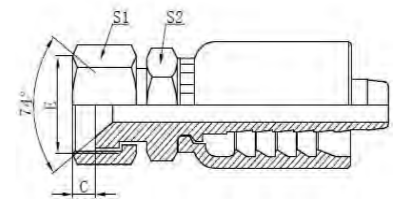

**Interlock JIC FEMALE 74 °Cone SAET / SAE J514 - 26713W**

Part No.	Thread	DN	A	C	S2
26713-12-12W	1.1/16**12	20	26.5	15	32
26713-16-16W	1.5/16**12	25	29.4	16	41
26713-20-20W	1.5/8**12	32	32.3	16.1	50
26713-24-24W	1.7/8**12	40	35.2	20	60
26713-32-32W	2.1/2**12	50	34.5	23.5	75

Material: Carbon steel #45 / Stainless steel  
 Application: Used for 4SP/4SH hose.

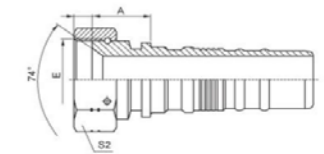

**Interlock JIC FEMALE 74 °Cone SAET Double Hexagon / SAE J514 - 26713D**

Part No.	Thread	DN	A	C	S1	S2
26713D-12-12W	1.1/16**12	20	37.5	15	30	32
26713D-16-16W	1.5/16**12	25	42.4	16	38	41
26713D-20-20W	1.5/8**12	32	47.3	17	46	50
26713D-24-24W	1.7/8**12	40	50.2	20	50	60
26713D-32-32W	2.1/2**12	50	52	23.5	65	75

Material: Carbon steel #45 / Stainless steel  
 Application: Used for 4SP/4SH hose.

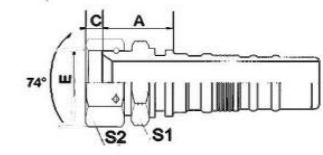

**Reusable JIC FEMALE 74 °Cone SAET Double nut / SAE J514 - 26718D-R5**

Part No.	Thread	DN	A	C	S1	S2
26718D-04-04-R5	7/16**20	6	22	9	14	15
26718D-05-05-R5	1/2**20	8	25.4	9.5	14	17
26718D-06-06-R5	9/16**18	10	24.5	10.5	17	19
26718D-08-08-R5	3/4**16	12	31.5	11	22	24
26718D-10-10-R5	7/8**14	16	34	13	27	27
26718D-12-12-R5	1.1/16**12	20	37	15	32	32
26718D-16-16-R5	1.5/16**12	25	33.5	16	38	41
26718D-20-20-R5	1.5/8**12	32	41.5	17	41	50
26718D-24-24-R5	1.7/8**12	40	43	20	46	55
26718D-32-32-R5	2.1/2**12	50	45.5	23.5	65	75

Material: Carbon steel #45 / Stainless steel  
 Application: Used for R5 hose

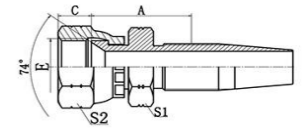

Hose  
 Ferrule  
 Fitting JIC  
 Fitting ORFS  
 Fitting NPT  
 Fitting SAE  
 Fitting BSP  
 Fitting Flange  
 Fitting Metric  
 Fitting JIS  
 Adapter  
 Quick Coupling  
 Camlock  
 Hose Clamp  
 Machine

**Reusable JIC FEMALE 74 °Cone SAET Double nut / SAE J514 - 26718R5T**

Part No.	Thread	DN	A	C	S2
26718-04-04-R5T	7/16**20	6	20.5	9	15
26718-05-05-R5T	1/2**20	8	23.4	9.5	17
26718-06-06-R5T	9/16**18	10	22.5	10.5	19
26718-08-08-R5T	3/4**16	12	23.5	11	24
26718-10-10-R5T	7/8**14	16	24	13	27
26718-12-12-R5T	1.1/16**12	20	26	15	32
26718-16-16-R5T	1.5/16**12	25	22.5	16	41
26718-20-20-R5T	1.5/8**12	32	24	17	50
26718-24-24-R5T	1.7/8**12	40	24	20	55
26718-32-32-R5T	2.1/2**12	50	26	23.5	75

Material: Carbon steel #45 / Stainless steel  
 Application: Used for R5 hose

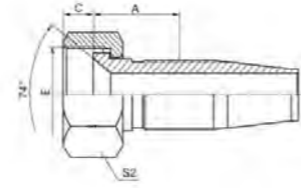

**One piece fitting 90°JIC FEMALE 74 °Cone SAET / SAE J514 -26791F**

Part No.	Thread	DN	C	S1	S2	H
26791F-04-04	7/16**20	6	9	17	17	28
26791F-06-06	9/16**18	10	10	19	19	36
26791F-08-08	3/4**16	12	11	24	22	42
26791F-10-10	7/8**14	16	12	27	27	55
26791F-12-12	1.1/16**12	20	13	32	32	58
26791F-16-16	1.5/16**12	25	14	38	38	68
26791F-20-20	1.5/8**12	32	15	50	50	76
26791F-24-24	1.7/8**12	40	19	55	55	90

Material: Carbon steel #45 / Stainless steel  
 Application: Used for 1SN/2SN hose.  
 Spiral hose fitting: 26792F

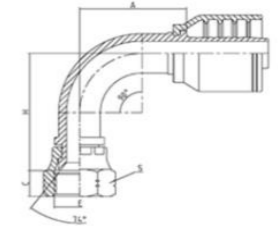

Hose  
 Ferrule  
 Fitting JIC  
 Fitting ORFS  
 Fitting NPT  
 Fitting SAE  
 Fitting BSP  
 Fitting Flange  
 Fitting Metric  
 Fitting JIS  
 Adapter  
 Quick Coupling  
 Camlock  
 Hose Clamp  
 Machine

**45°JIC FEMALE 74 °Cone SAET / SAE J514 - 26741**

Part No.	Thread	DN	A	C	H	S2
26741-04-04	7/16**20	6	40.2	9	18.1	15
26741-05-05	1/2**20	8	42.7	9.5	19.3	17
26741-06-06	9/16**18	10	44.3	10.5	20	19
26741-08-08	3/4**16	12	58.6	11	23.5	24
26741-10-10	7/8**14	16	70.1	13	25.3	27
26741-12-12	1.1/16**12	20	77.4	15	30	32
26741-16-16	1.5/16**12	25	85.7	16	31.5	41
26741-20-20W	1.5/8**12	32	96.6	17	35.9	50
26741-24-24W	1.7/8**12	40	114.8	20	44.1	55
26741-32-32W	2.1/2**12	50	135.9	23.5	51.6	75

Material: Carbon steel #45 / Stainless steel  
 Application: Used for 1SN/2SN hose.  
 T type fitting: 26741T  
 Spiral hose fitting: 26742

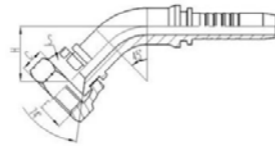

**Interlock 90°JIC FEMALE 74 °Cone SAET / SAE J514 -26793W**

Part No.	Thread	DN	A	C	H	S2
26793-12-12W	1.1/16**12	20	73.8	15	64.5	32
26793-16-16W	1.5/16**12	25	88.9	16	72.5	41
26793-20-20W	1.5/8**12	32	105.8	16.1	81.5	50
26793-24-24W	1.7/8**12	40	124.2	20	101	55
26793-32-32W	2.1/2**12	50	150.3	23.5	121.3	75

Material: Carbon steel #45 / Stainless steel  
 Application: Used for 4SP/4SH hose.

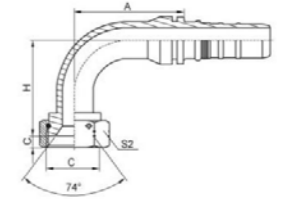

**Reusable JIC FEMALE 74 °Cone SAET Double nut / SAE J514 - 26798D-R5**

Part No.	Thread	DN	A	C	H	S1	S2
26798D-04-04-R5	7/16**20	6	38.5	9	33.5	14	15
26798D-05-05-R5	1/2**20	8	43.4	9.5	37	14	17
26798D-06-06-R5	9/16**18	10	44.8	10.5	39.3	17	19
26798D-08-08-R5	3/4**16	12	53	11	47.5	19	24
26798D-10-10-R5	7/8**14	16	66.5	13	52.5	24	27
26798D-12-12-R5	1.1/16**12	20	79.5	15	63.5	27	32
26798D-16-16-R5	1.5/16**12	25	86.5	16	70	32	41
26798D-20-20-R5W	1.5/8**12	32	100.5	17	85	41	50
26798D-24-24-R5W	1.7/8**12	40	121	20	97.5	46	55
26798D-32-32-R5W	2.1/2**12	50	143.3	23.5	118.8	65	75

Material: Carbon steel #45 / Stainless steel  
 Application: Used for R5 hose

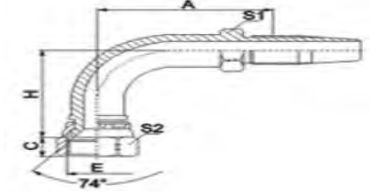

26798D-R5

**One Piece Fitting 45°JIC FEMALE 74 °Cone SAET / SAE J514 - 26741F**

Part No.	Thread	DN	C	S1	S2	H
26741F-04-04	7/16**20	6	9	17	17	15
26741F-06-06	9/16**18	10	10	19	19	20
26741F-08-08	3/4**16	12	11	24	22	20
26741F-10-10	7/8**14	16	12	27	27	24
26741F-12-12	1.1/16**12	20	13	32	32	27
26741F-16-16	1.5/16**12	25	14	38	38	31.5
26741F-20-20	1.5/8**12	32	15	50	50	35
26741F-24-24	1.7/8**12	40	19	55	55	42

Material: Carbon steel #45 / Stainless steel  
 Application: Used for 1SN/2SN hose.  
 Spiral hose fitting: 26742F

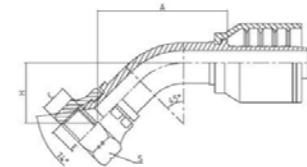

**90°JIC FEMALE 74 °Cone SAET / SAE J514 - 26791**

Part No.	Thread	DN	A	C	H	S2
26791-04-04	7/16**20	6	30	9	33.5	15
26791-05-05	1/2**20	8	33	9.5	37	17
26791-06-06	9/16**18	10	35.3	10.5	39.3	19
26791-08-08	3/4**16	12	41	11	47	24
26791-10-10	7/8**14	16	56.5	13	52.5	27
26791-12-12	1.1/16**12	20	65.5	15	63.5	32
26791-16-16	1.5/16**12	25	76.7	16	70	41
26791-20-20W	1.5/8**12	32	91.5	17	80.5	50
26791-24-24W	1.7/8**12	40	109.4	20	94	55
26791-32-32W	2.1/2**12	50	133.1	23.5	121.8	75

Material: Carbon steel #45 / Stainless steel  
 Application: Used for 1SN/2SN hose.  
 Spiral hose fitting: 26792

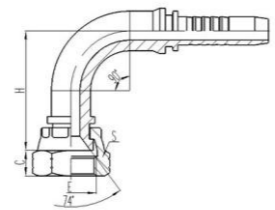

Hose  
Ferrule  
Fitting JIC  
Fitting ORFS  
Fitting NPT  
Fitting SAE  
Fitting BSP  
Fitting Flange  
Fitting Metric  
Fitting JIS  
Adapter  
Quick Coupling  
Camlock  
Hose Clamp  
Machine

**ORFS Male O-ring Seal / ISO 4834 / SAE J453 - 14211**

Part No.	Thread	DN	O-ring	A	C	S1
14211-04-04	9/16**16	6	O011	22.5	9.8	17
14211-06-06	11/16**16	10	O012	24	11.2	19
14211-08-08	13/16**16	12	O014	28.5	12.8	22
14211-10-10	1**14	16	O016	33.5	15.5	27
14211-12-12	1.3/16**12	20	O018	36.5	17	32
14211-16-16	1.7/16**12	25	O021	38.5	17.5	38
14211-20-20	1.11/16**12	32	O025	41.5	17.5	46
14211-24-24	2**12	40	O029	46.5	17.5	55

Material: Carbon steel #45 / stainless steel  
Application: Used for 1SN/2SN hose.  
Spiral hose fitting: 14212  
One piece fitting: 14211F

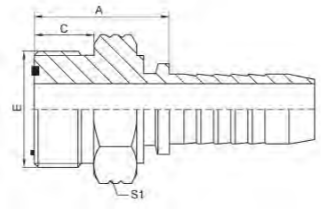

**90°ORFS Female Flat Seat / ISO 12151-1 / SAE J516 - 24291**

Part No.	Thread	DN	A	C	H	S2
24291-04-04	9/16**18	6	30	8.5	41	19
24291-06-05T	11/16**16	8	33	10	37.5	22
24291-06-06	11/16**16	10	35.8	10	49.8	22
24291-08-08	13/16**16	12	41	11	57	27
24291-10-10	1**14	16	56.5	13.5	66	30
24291-12-12	1.3/16**12	20	65.5	15	77	36
24291-16-14T	1.7/16**12	22	41.2	14.8	63	41
24291-16-16T	1.7/16**12	25	76.9	14.8	67.5	41
24291-20-20W	1.11/16**12	32	93	15	100	50
24291-24-20T	2**12	32	91.5	14.8	78.5	60
24291-24-24T	2**12	40	109	14.8	92	60

Material: Carbon steel #45 / Stainless steel  
Application: Used for 1SN/2SN hose.  
T type fitting: 24291T  
Double nut fitting: 24291D  
Spiral hose fitting: 24292

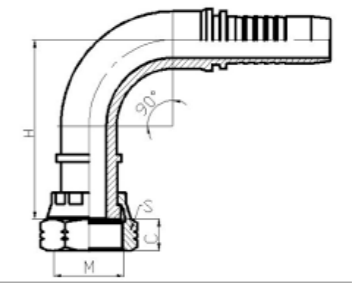

**ORFS Female Flat Seat / ISO 12151-1 / SAE J516 - 24211**

Part No.	Thread	DN	A	C	S2
24211-04-04	9/16**18	6	22.5	8.5	19
24211-06-06	11/16**16	10	25.5	10	22
24211-08-08	13/16**16	12	28	11	27
24211-10-10	1**14	16	33.5	13.5	30
24211-12-12	1.3/16**12	20	35	15	36
24211-16-14T	1.7/16**12	22	34	14.8	41
24211-16-16T	1.7/16**12	25	35	14.8	41
24211-20-20W	1.11/16**12	32	39.5	15	50
24211-24-20T	2**12	32	36	14.8	60
24211-24-24T	2**12	40	36	14.8	60

Material: Carbon steel #45 / Stainless steel  
Application: Used for 1SN/2SN hose.  
T type fitting: 24211T  
Double nut fitting: 24211D  
Spiral hose fitting: 24212

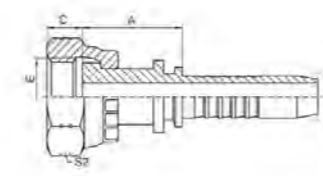

**Interlock ORFS Female Flat Seat - 24213W**

Part No.	Thread	DN	A	C	S2
24213-12-12W	1.3/16**12	20	41	15	36
24213-16-16W	1.7/16**12	25	44.4	15	41
24213-20-20W	1.11/16**12	32	47.8	15	50
24213-24-24W	2**12	40	48.2	15	60

Material: Carbon steel #45 / stainless steel  
Application: Used for 4SP/4SH hose.

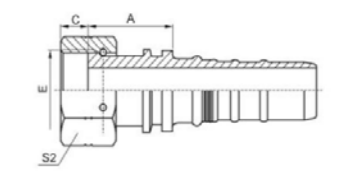

**Interlock 45°ORFS Female Flat Seat - 24243W**

Part No.	Thread	DN	A	C	H	S2
24243-12-12W	1.3/16**12	20	97.7	15	42	36
24243-16-16W	1.7/16**12	25	111	15	44.6	41
24243-20-20W	1.11/16**12	32	124	15	49	50
24243-24-24W	2**12	40	138	15	53.6	60

Material: Carbon steel #45 / stainless steel  
Application: Used for 4SP/4SH hose.

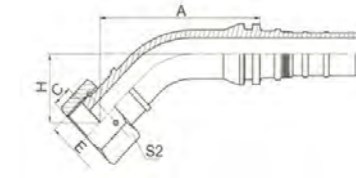

**Reusable ORFS Female Flat Seat Double Hexagon 24218D-R5**

Part No.	Thread	DN	A	C	S1	S2
24218D-05-05(R5)	1/2**20	8	25.4	9.5	14	17
24218D-08-08(R5)	3/4**16	12	31.5	11	22	24
24218D-12-12(R5)	1.1/16**12	20	37	15	32	32
24218D-20-20(R5)W	1.5/8**12	32	41.5	17	41	50
24218D-32-32(R5)W	2.1/2**12	51	45.5	23.5	65	75

Material: Carbon steel #45 / Stainless steel  
Application: Used for R5 hose.

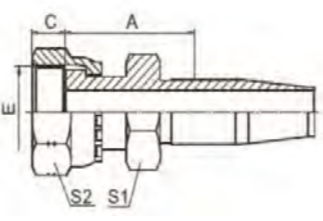

**Interlock 90°ORFS Female Flat Seat - 24293**

Part No.	Thread	DN	A	C	H	S2
24293-12-12W	1.3/16**12	20	73.8	15	80.5	36
24293-16-16W	1.7/16**12	25	88.9	15	88.5	41
24293-20-20W	1.11/16**12	32	106	15	100	50
24293-24-24W	2**12	40	123	15	115	60

Material: Carbon steel #45 / stainless steel  
Application: Used for 4SP/4SH hose.

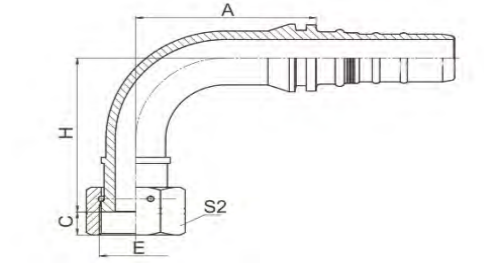

Hose  
Ferrule  
Fitting JIC  
Fitting ORFS  
Fitting NPT  
Fitting SAE  
Fitting BSP  
Fitting Flange  
Fitting Metric  
Fitting JIS  
Adapter  
Quick Coupling  
Camlock  
Hose Clamp  
Machine



Hose  
Ferrule  
Fitting JIC  
Fitting ORFS  
Fitting NPT  
Fitting SAE  
Fitting BSP  
Fitting Flange  
Fitting Metric  
Fitting JIS  
Adapter  
Quick Coupling  
Camlock  
Hose Clamp  
Machine

**NPT Male - 15611**

Part No.	Thread	DN	A	C	S1
15611-02-03	Z1/8**27	5	22.5	10.5	12
15611-04-04	Z1/4**18	6	28	15	17
15611-06-05	Z3/8**18	8	28	16	19
15611-06-06	Z3/8**18	10	30	16	19
15611-08-08	Z1/2**14	12	34.5	19.5	22
15611-12-10	Z3/4**14	16	38	19.5	27
15611-12-12	Z3/4**14	20	38.5	19.5	27
15611-16-12	Z1**11.5	20	45	25.5	36
15611-16-16	Z1**11.5	25	44.5	25.5	36
15611-20-20	Z1.1/4**11.5	32	49	26.5	46
15611-24-24	Z1.1/2**11.5	40	51	27.5	50
15611-32-32	Z2**11.5	50	55	27.5	65

Material: Carbon steel #45 / Stainless steel  
Application: Used for 1SN/2SN hose.  
Spiral hose fitting: 15612  
One Piece fitting: 15611F

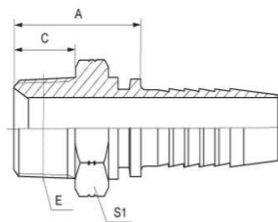

**NPT Swivel Male - 15611SW**

Part No.	Thread	DN	A	S1
15611SW-04-04	Z1/4**18	6	56	19
15611SW-06-06	Z3/8**18	10	60	22
15611SW-08-08	Z1/2**14	12	66	27
15611SW-12-12	Z3/4**14	20	68.4	32

Material: Carbon steel #45 / Stainless steel  
Application: Used for 1SN/2SN hose.

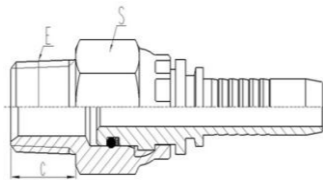

**90°NPT Swivel Male - 15691KSW**

Part No.	Thread	DN	A	H	S1	S2
15691KSW-04-04	Z1/4**18	6	25	59.5	16	19
15691KSW-06-06	Z3/8**18	10	25	64.5	16	22
15691KSW-08-08	Z1/2**14	12	28.5	71.5	19	27
15691KSW-12-12	Z3/4**14	20	36	76.9	27	32

Material: Carbon steel #45 / Stainless steel  
Application: Used for 1SN/2SN hose.

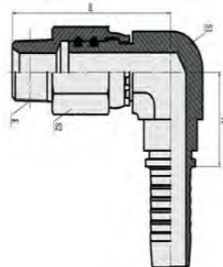

**Interlock NPT Male - 15613**

Part No.	Thread	DN	A	C	S1
15613-12-12	Z3/4**14	20	37.5	19.5	30
15613-16-16	Z1**11.5	25	45.9	25.5	38
15613-20-20	Z1**11.5	32	51.3	26.5	46
15613-24-24	Z1.1/2**11.5	40	54.2	27.5	50
15613-32-32	Z2**11.5	50	56.5	27.5	65

Material: Carbon steel #45 / Stainless steel  
Application: Used for 4SP/4SH hose.

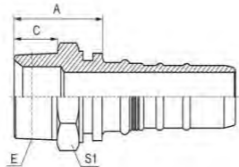

**Reusable fitting NPT Male for R5 hose - 15618 R5**

Part No.	Thread	DN	A	S1
15618-02-04(R5)	Z1/8**27	6	25.5	12
15618-04-04(R5)	Z1/4**18	6	30	17
15618-04-06(R5)	Z1/4**18	10	31	17
15618-06-05(R5)	Z3/8**18	8	32.9	19
15618-06-06(R5)	Z3/8**18	10	32	19
15618-08-08(R5)	Z1/2**14	12	40.5	22
15618-12-10(R5)	Z3/4**14	16	42.5	30
15618-12-12(R5)	Z3/4**14	20	43	30
15618-16-16(R5)	Z1.1/4**11.5	25	46.5	36
15618-20-20(R5)	Z1.1/4**11.5	32	51.5	46
15618-24-24(R5)	Z1.1/2**11.5	40	52.5	50
15618-32-32(R5)	Z2**11.5	50	55	65

Material: Carbon steel #45 / Stainless steel  
Application: Used for R5 hose.

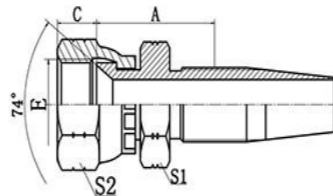

**NPSM Female 60° cone / SAE J514 - 21611**

Part No.	Thread	DN	A	B	S2
21611-04-04	1/4**18	6	22	4.6	19
21611-06-05	3/8 **18	8	23	6	22
21611-06-06	3/8 **18	10	23	6	22
21611-08-08	1/2" *14	12	23.5	7.5	27
21611-12-10	3/4 **14	16	27	8.9	32
21611-12-12	3/4 **14	20	27	8.9	32
21611-16-16	1" *11.5	25	28.5	10.5	41
21611-20-20W	1.1/4**11.5	32	29.5	11.2	50
21611-24-24W	1.1/2**11.5	40	31.5	11.2	55
21611-32-32W	2**11.5	50	31	11.2	70

Material: Carbon steel #45 / Stainless steel  
Application: Used for 1SN/2SN hose.  
T type fitting: 21611T  
Double nut fitting: 21611D  
Spiral hose fitting: 21612  
One piece fitting:21611F

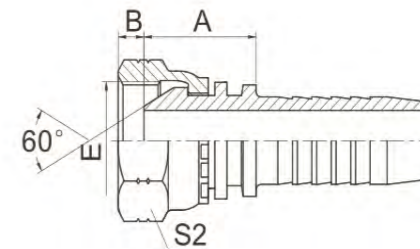

**45° NPSM Female 60° cone / SAE J514 - 21641**

Part No.	Thread	DN	A	B	H	S2
21641-04-04	1/4**18	6	45.1	4.6	23	19
21641-06-06	3/8 **16	10	47.2	6	24.9	22
21641-08-08	1/2" *14	12	62.7	7.5	27.7	27
21641-12-12	3/4 **14	20	81.4	8.9	34	32
21641-16-16	1" *11.5	25	89.2	10.5	35	41
21641-20-20W	1.1/4**11.5	32	99.8	11.2	39.3	50
21641-20-24W	1.1/2**11.5	40	115.1	11.2	44.4	55
21641-32-32W	2**11.5	50	136.4	11.2	63.4	70

Material: Carbon steel #45 / Stainless steel  
Application: Used for 1SN/2SN hose.  
T type fitting: 21641T  
Double nut fitting: 21641D  
Spiral hose fitting: 21642  
One piece fitting:21641F

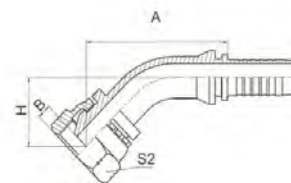

**90° NPSM Female 60° cone / SAE J514 - 21691**

Part No.	Thread	DN	A	C	H	S2
21691-04-04	1/4**18	6	30	4.6	40.5	19
21691-06-05	3/8 **18	8	34	6	40.7	22
21691-06-06	3/8 **18	10	35.3	6	45.3	22
21691-08-08	1/2" *14	12	41	7.5	53.2	27
21691-12-10	3/4 **14	16	56.6	8.9	53.2	32
21691-12-12	3/4 **14	20	65.5	8.9	69.1	32
21691-16-16	1" *11.5	25	76.7	10.5	75	41
21691-20-20W	1.1/4**11.5	32	91.5	11.2	86	50
21691-24-24W	1.1/2**11.5	40	109.4	11.2	102	55
21691-32-32W	2**11.5	50	131.8	11.2	125	70

Material: Carbon steel #45 / Stainless steel  
Application: Used for 1SN/2SN hose.  
T type fitting: 21691T  
Double nut fitting: 21691D  
Spiral hose fitting: 21692  
One piece fitting:21691F

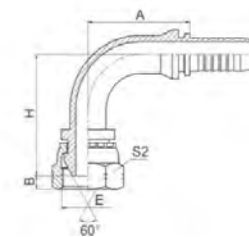

**Reusable 90° NPSM Female 60° cone / SAE J514 21698D-R5**

Part No.	Thread	DN	A	C	H	S2	S2
21698D-04-04R5	1/4**18	6	38.5	4.6	40.5	14	22
21698D-06-05R5	3/8 **18	8	43.4	6	43	14	22
21698D-06-06R5	3/8 **18	10	44.8	6	45.3	17	27
21698D-08-08R5	1/2" *14	12	53	7.5	53.2	19	32
21698D-12-10R5	3/4 **14	16	66.5	8.9	53.5	24	32
21698D-12-12R5	3/4 **14	20	79.5	8.9	69.1	27	41
21698D-16-16R5	1" *11.5	25	86.5	10.5	75	32	50
21698D-20-20R5W	1.1/4**11.5	32	100.5	11.2	86	41	55
21698D-24-24R5W	1.1/2**11.5	40	108	11.2	102	46	70
21698D-32-32R5W	2**11.5	50	128.8	11.2	125	65	70

Material: Carbon steel #45 / Stainless steel  
Application: Used for R5 hose.

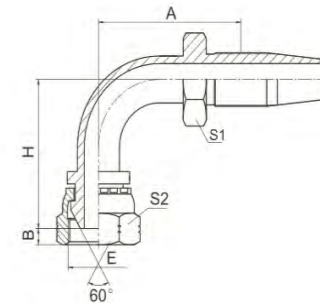

Hose  
Ferrule  
Fitting JIC  
Fitting ORFS  
Fitting NPT  
Fitting SAE  
Fitting BSP  
Fitting Flange  
Fitting Metric  
Fitting JIS  
Adapter  
Quick Coupling  
Camlock  
Hose Clamp  
Machine



Hose  
 Ferrule  
 Fitting JIC  
 Fitting ORFS  
 Fitting NPT  
 Fitting SAE  
 Fitting BSP  
 Fitting Flange  
 Fitting Metric  
 Fitting JIS  
 Adapter  
 Quick Coupling  
 Camlock  
 Hose Clamp  
 Machine

**SAE O-ring Male / ISO 11926/ SAE J1926 -16011**

Part No.	Thread	DN	O-ring	A	C	S1
16011-04-04	7/16**20	6	O904	21.5	9.1	14
16011-05-04	1/2**20	6	O905	21.5	9.1	17
16011-06-05	9/16**18	8	O906	22.5	9.9	17
16011-06-06	9/16**18	10	O906	22.5	9.9	17
16011-08-06	3/4**16	10	O908	24.5	11.1	22
16011-08-08	3/4**16	12	O908	25	11.1	22
16011-10-08	7/8**14	12	O910	29.5	12.7	27
16011-10-10	7/8**14	16	O910	30.5	12.7	27
16011-12-10	1.1/16**12	16	O912	34	15.1	32
16011-12-12	1.1/16**12	20	O912	34	15.1	32
16011-16-16	1.5/16**12	25	O916	36	15.1	38

Material: Carbon steel #45 / Stainless steel  
 Application: Used for 1SN/2SN hose.  
 Spiral hose fitting: 16012  
 One piece fitting: 16011F

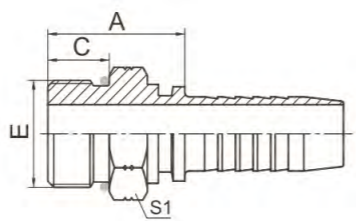

**SAE Male 90° cone / SAE J513 -17811**

Part No.	Thread	DN	A	C	S1
17811-04-04	7/16**20	6	25.5	12.7	12
17811-05-05	1/2**20	8	27	14.2	14
17811-06-06	5/8**18	10	28.5	15.7	17
17811-08-08	3/4**16	12	34	19	22
17811-10-10	7/8**14	16	38.5	22.4	24
17811-12-12	1.1/16**12	20	43.5	25.4	30

Material: Carbon steel #45 / Stainless steel  
 Application: Used for 1SN/2SN hose.  
 Spiral hose fitting: 17812  
 One piece fitting: 17811F

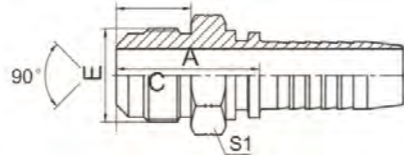

**Reusable SAE Male 90° cone / SAE J5132 - 17818**

Part No.	Thread	DN	A	S1
17818-06-06R5	5/8**18	10	33.7	17
17818-08-08R5	3/4**16	12	42	22
17818-12-12R5	1.1/16**12	20	51	30

Material: Carbon steel #45 / Stainless steel  
 Application: Used for R5 hose.

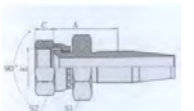

**SAE Female 90° cone seat / SAE J513 - 27811**

Part No.	Thread	DN	A	C	S2
27811-04-03	7/16**20	5	14	9	15
27811-04-04	7/16**20	6	15	9	15
27811-05-05	1/2**20	8	15.5	9.5	17
27811-06-06	5/8**18	10	17	11.3	22
27811-08-08	3/4**16	12	18	11	24
27811-10-10	7/8**14	16	20	13	27
27811-12-12	1.1/16**14	20	21.5	14.3	32

Material: Carbon steel #45 / Stainless steel  
 T type fitting: 27811T  
 Double nut fitting: 27811D  
 Spiral hose fitting: 27812  
 One piece fitting: 27811F

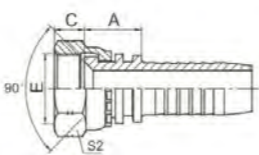

**45°SAE Female 90° cone seat / SAE J513 - 27841**

Part No.	Thread	DN	A	C	H	S2
27841-04-03	7/16**20	5	37.6	9	17.2	15
27841-06-04	5/8**18	6	42	11.3	19.9	22
27841-06-05	5/8**18	8	44.1	11.3	20.7	22
27841-06-06	5/8**18	10	45.7	11.3	21.4	22
27841-08-08	3/4**16	12	58.2	11	23.3	24
27841-10-08	7/8**14	12	58.2	13	23.3	27
27841-10-10	7/8**14	16	69.4	13	24.6	27
27841-12-12	1.1/16**12	20	77.4	14.3	30	32

Material: Carbon steel #45 / Stainless steel  
 Application: Used for 1SN/2SN hose.  
 T type fitting: 27841T  
 Double nut fitting: 27841D  
 Spiral hose fitting: 27842  
 One piece fitting: 27841F

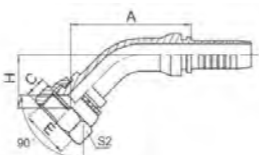

**90°SAE Female 90° cone seat / SAE J513 - 27891**

Part No.	Thread	DN	A	C	H	S2
27891-04-03	7/16**20	5	26.5	9	30.5	15
27891-06-04	5/8**18	6	30	11.3	36	22
27891-06-05	5/8**18	8	33	11.3	39	22
27891-06-06	5/8**18	10	35.3	11.3	41.3	22
27891-10-08	7/8**14	12	41	13	47	27
27891-10-10	7/8**14	16	56.5	13	51.5	27
27891-12-12	1.1/16**12	20	65.5	14.3	63.5	32

Material: Carbon steel #45 / Stainless steel  
 Application: Used for 1SN/2SN hose.  
 T type fitting: 27891T  
 Spiral hose fitting: 27892  
 One piece fitting: 27891F

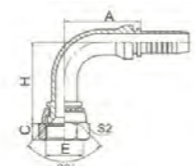

**Reusable SAE Female 90° cone seat - 27818D-R5**

Part No.	Thread	DN	A	C	S1	S2
27818D-04-04(R5)	7/16**20	6	22	9	14	17
27818D-05-05(R5)	1/2**20	8	25.4	9	14	17
27818D-06-06(R5)	5/8**18	10	26	11.3	17	22
27818D-08-08(R5)	3/4**16	12	31.5	10.5	22	24
27818D-10-10(R5)	7/8**14	16	34	12	27	27
27818D-12-12(R5)	1.1/16**14	20	37	14.3	32	32

Material: Carbon steel #45 / Stainless steel  
 Application: Used for R5 hose.

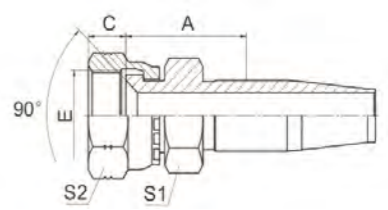

**Reusable SAE Female 90° cone seat - 27818D-R5T**

Part No.	Thread	DN	C	S2
27818-04-04(R5T)	7/16**20	6	9	15
27818-05-05(R5T)	1/2**20	8	9	17
27818-06-06(R5T)	5/8**18	10	11.3	22
27818-08-08(R5T)	3/4**16	12	10.5	24
27818-10-10(R5T)	7/8**14	16	12	27
27818-12-12(R5T)	1.1/16**14	20	14.3	32

Material: Carbon steel #45 / Stainless steel  
 Application: Used for R5 hose.

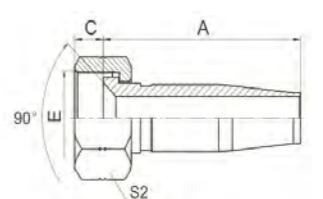

**Reusable SAE Female 90° cone seat - 27898D-R5**

Part No.	Thread	DN	A	C	S1	S2
27898D-06-06(R5)	5/8**18	10	44.8	11.3	17	22
27898D-08-08(R5)	3/4**16	12	53	10.5	19	24

Material: Carbon steel #45 / Stainless steel  
 Application: Used for R5 hose.

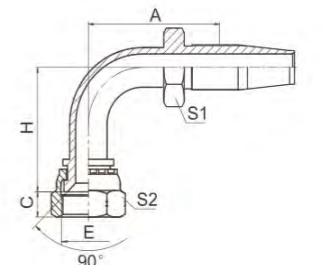

Hose  
 Ferrule  
 Fitting JIC  
 Fitting ORFS  
 Fitting NPT  
 Fitting SAE  
 Fitting BSP  
 Fitting Flange  
 Fitting Metric  
 Fitting JIS  
 Adapter  
 Quick Coupling  
 Camlock  
 Hose Clamp  
 Machine



Hose  
 Ferrule  
 Fitting JIC  
 Fitting ORFS  
 Fitting NPT  
 Fitting SAE  
 Fitting BSP  
 Fitting Flange  
 Fitting Metric  
 Fitting JIS  
 Adapter  
 Quick Coupling  
 Camlock  
 Hose Clamp  
 Machine

**45°BSP Female flat seat/ ISO 8434-6 / BS 5200 - 22241**

Part No.	Thread	DN	A	C	H	S2
22241-04-04	G1/4**19	6	40.9	8	18.8	19
22241-06-06	G3/8**19	10	45.3	9	21	22
22241-08-08	G1/2**14	12	58.9	10.5	24	27
22241-12-12	G3/4**14	20	77.4	13.5	30	32
22241-16-16	G1**11	25	82.7	15.5	31.5	41
22241-20-20W	G1.1/4**11	32	97.3	15.5	36.6	50

Material: Carbon steel #45 / Stainless steel  
 Application: Used for 1SN/2SN hose.  
 Spiral hose fitting: 22242

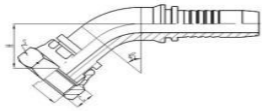

**90°BSP Female flat face / ISO 8434-6 / BS 5200 - 22291**

Part No.	Thread	DN	A	C	H	S2
22291-04-04	G1/4**19	6	30	8	34.5	19
22291-06-06	G3/8**19	10	35.3	9	41.3	22
22291-08-08	G1/2**14	12	41	10.5	48	27
22291-12-12	G3/4**14	20	65.5	13.5	63.5	32
22291-16-16	G1**11	25	76.7	15.5	70	41
22291-20-20W	G1.1/4**11	32	91.5	15.5	82.5	50
22291-24-24W	G1.1/2**11	40	109.4	17.5	98.5	55

Material: Carbon steel #45 / Stainless steel  
 Application: Used for 1SN/2SN hose.  
 Spiral hose fitting: 22292

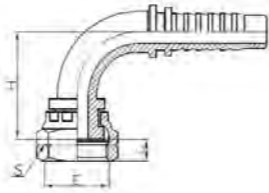

**BSP Male 60°Cone seat - 12611**

Part No.	Thread	DN	A	C	S1
12611-04-04	G1/4**19	6	24.5	12	14
12611-06-06	G3/8**19	10	27.5	13.5	17
12611-08-08	G1/2**14	12	31	16	22
12611-10-10	G5/8**14	16	33.5	17.5	24
12611-12-12	G3/4**14	20	36.5	18.5	27
12611-16-16	G1**11	25	41.5	20.5	36
12611-20-20	G1.1/4**11	32	44.5	20.5	46
12611-24-24	G1.1/2**11	40	46	23	50
12611-32-32	G2**11	50	53.5	25.5	65

Material: Carbon steel #45 / Stainless steel  
 Application: Used for 1SN/2SN hose.  
 Spiral hose fitting: 12612

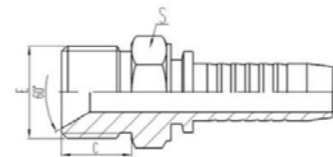

**BSP Male double for 60°Cone seat or Bonded seal - 12611A**

Part No.	Thread	DN	A	C	S1
12611A-04-04	G1/4**19	6	24.5	12	19
12611A-06-05	G3/8**19	8	26	13.5	22
12611A-06-06	G3/8**19	10	28	13.5	22
12611A-08-08	G1/2**14	12	33.5	16	27
12611A-10-10	G5/8**14	16	36	17.5	30
12611A-12-12	G3/4**14	20	37.5	18.5	32
12611A-16-16	G1**11	25	43.5	20.5	41
12611A-20-20	G1.1/4**11	32	46.5	20.5	50
12611A-24-24	G1.1/2**11	40	49	23	55
12611A-32-32	G2**11	50	54.5	25.5	70

Material: Carbon steel #45 / Stainless steel  
 Application: Used for 1SN/2SN hose.  
 Spiral hose fitting: 12612A

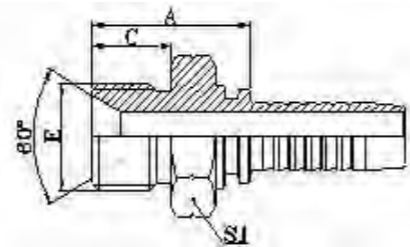

**Interlock BSP Male 60°cone seat fitting / ISO 8434-6 / BS 5200 - 12613**

Part No.	Thread	DN	A	C	S1
12613-12-12	G3/4**14	20	37.5	18.5	30
12613-16-16	G1**11	25	41	20.5	36
12613-20-20	G1.1/4**11	32	45.3	20.5	46
12613-24-24	G1.1/2**11	40	49.7	23	50
12613-32-32	G2**11	50	52	25.5	60

Material: Carbon steel #45 / Stainless steel  
 Application: Used for 4SP/4SH hose.

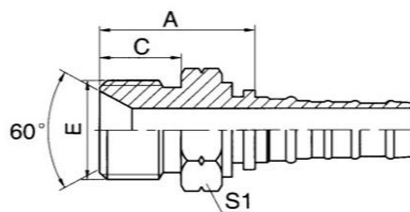

**BSP FEMALE 60°Cone seal/ ISO 8434-6 / BS 5200 - 22611**

Part No.	Thread	DN	A	C	S1
22611-02-03	G1/8**28	5	15	5.5	14
22611-04-03	G1/4**19	5	17	5.5	19
22611-04-04	G1/4**19	6	18	5.5	19
22611-06-05	G3/8**19	8	19	6.3	22
22611-06-06	G3/8**19	10	19.5	6.3	22
22611-08-08	G1/2**14	12	21.5	7.5	27
22611-10-10	G5/8**14	16	23.5	9.5	30
22611-12-12	G3/4**14	20	24	10.9	32
22611-16-12T	G1**11	20	24	11.7	41
22611-16-16	G1**11	25	27	11.7	41
22611-20-20W	G1.1/4**11	32	30.5	11	50
22611-24-20T	G1.1/2**11	32	32	13	55
22611-24-24W	G1.1/2**11	40	32	13	55
22611-32-24T	G2**11	40	30	16	70
22611-32-32W	G2**11	50	31.9	16	70

Material: Carbon steel #45 / Stainless steel  
 Application: Used for 1SN/2SN hose.  
 Spiral hose fitting: 22612  
 Socketless hose fittings: 22611-PO

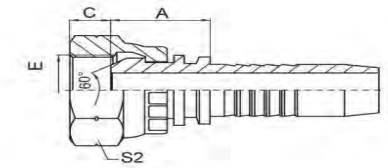

**BSP FEMALE 60°CONE SEAT DOUBLE HEXAGON/ ISO 8434-6 / BS 5200 -22611D**

Part No.	Thread	DN	A	C	S1	S2
22611D-04-04	G1/4**19	6	23.5	5.5	19	19
22611D-06-06	G3/8**19	10	26.5	6.3	22	22
22611D-08-08	G1/2**14	12	31	7.5	27	27
22611D-10-10	G5/8**14	12	32	9.5	30	30
22611D-12-08	G3/4**14	12	33	10.9	32	32
22611D-12-12	G3/4**14	20	34	10.9	32	32
22611D-16-16	G1**11	25	35.5	11.7	41	41
22611D-20-20	G1.1/4**11	32	43.5	11	50	50

Material: Carbon steel #45 / Stainless steel  
 Application: Used for 1SN/2SN hose.  
 Spiral fitting:22612D

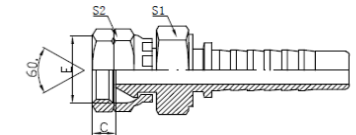

**One Piece fitting BSP FEMALE 60°CONE SEAT INTEGRAL FITTINGS/ ISO 8434-6 / BS 5200 - 22611F**

Part No.	Thread	DN	C	S1	S2
22611F-04-04B	G1/4**19	6	5.5	17	17
22611F-06-04B	G3/8**19	6	6	22	17
22611F-06-06B	G3/8**19	10	6	22	19
22611F-08-08B	G1/2**14	12	7	27	22
22611F-10-08B	G5/8**14	12	8.5	27	22
22611F-12-12B	G3/4**14	20	9	32	32
22611F-16-16B	G1**11	25	11	38	38
22611F-20-20B	G1.1/4**11	32	11	50	50
22611F-24-24B	G1.1/2**11	40	12	55	55

Material: Carbon steel #45 / Stainless steel  
 Application: Used for 1SN/2SN hose.  
 Spiral fitting:22612F

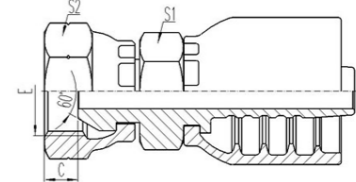

**Interlock BSP FEMALE 60°CONE / ISO 8434-6 / BS 5200 - 22613W**

Part No.	Thread	DN	A	C	S2
22613-12-12W	G3/4**14	20	26.5	10.9	32
22613-16-16W	G1**11	25	30.4	11.7	41
22613-20-20W	G1.1/4**11	32	35.8	11	50
22613-24-24W	G1.1/2**11	40	36.7	14	55
22613-32-32W	G2**11	50	36.5	16	70

Material: Carbon steel #45 / Stainless steel  
 Application: Used for 4SP/4SH hose.

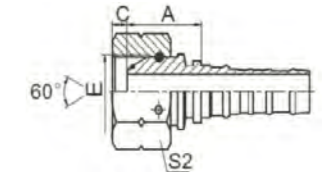

**Interlock BSP FEMALE 60°CONE O-RING / ISO 8434-6 / BS 5200 - 22613ORW**

Part No.	Thread	DN	A	C	S2	O-ring
22613-12-12ORW	G3/4**14	20	26.5	10.9	32	O171
22613-16-16ORW	G1**11	25	30.4	11.7	41	O221
22613-20-20ORW	G1.1/4**11	32	35.8	11	50	O291
22613-24-24ORW	G1.1/2**11	40	36.7	14	55	O351

Material: Carbon steel #45 / Stainless steel  
 Application: Used for 4SP/4SH hose.

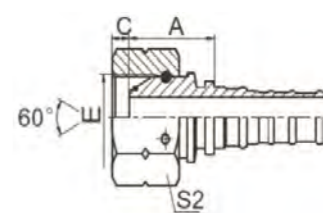

Hose  
 Ferrule  
 Fitting JIC  
 Fitting ORFS  
 Fitting NPT  
 Fitting SAE  
 Fitting BSP  
 Fitting Flange  
 Fitting Metric  
 Fitting JIS  
 Adapter  
 Quick Coupling  
 Camlock  
 Hose Clamp  
 Machine

- Hose
- Ferrule
- Fitting JIC
- Fitting ORFS
- Fitting NPT
- Fitting SAE
- Fitting BSP
- Fitting Flange
- Fitting Metric
- Fitting JIS
- Adapter
- Quick Coupling
- Camlock
- Hose Clamp
- Machine

**Reusable BSP FEMALE 60° CONE / ISO 8434-6 / BS 5200 - 22618D**

Part No.	Thread	DN	A	C	S1	S2
22618D-04-04(R5)	G1/4**19	6	26	5.5	14	19
22618D-06-05(R5)	G3/8**19	8	29.1	6.3	17	22
22618D-06-06(R5)	G3/8**19	10	30	6.3	17	22
22618D-08-08(R5)	G1/2**14	12	35	7.5	19	27
22618D-10-10(R5)	G5/8**14	16	35.5	9.5	22	30
22618D-12-12(R5)	G3/4**14	19	38.5	10.9	27	32
22618D-16-16(R5)	G1**11	25	37	11.7	32	41
22618D-20-20(R5)	G1.1/4**11	32	41.5	11	41	50

Material: Carbon steel #45 / Stainless steel  
Application: Used for R5 hose.

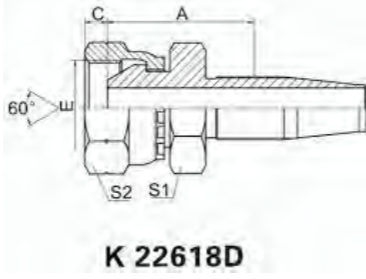

**Reusable BSP FEMALE 60° CONE / ISO 8434-6 / BS 5200 - 22618D-R5T**

Part No.	Thread	DN	C	S2
22618-04-04(R5T)	G1/4**19	6	5.5	19
22618-06-05(R5T)	G3/8**19	8	6.3	22
22618-06-06(R5T)	G3/8**19	10	6.3	22
22618-08-08(R5T)	G1/2**14	12	7.5	27
22618-10-10(R5T)	G5/8**14	16	9.5	30
22618-12-12(R5T)	G3/4**14	19	10.9	32
22618-16-16(R5T)	G1**11	25	11.7	41
22618-20-20(R5T)	G1.1/4**11	32	11	50
22618-24-24(R5T)	G1.1/2**11	38	13	55

Material: Carbon steel #45 / Stainless steel  
Application: Used for R5 hose.

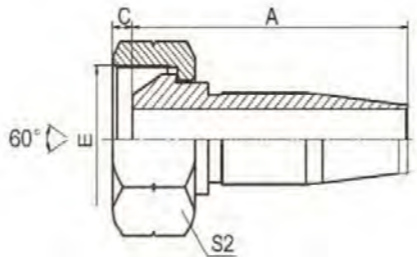

**45° BSP FEMALE 60° CONE / ISO 8434-6 / BS 5200 -22641**

Part No.	Thread	DN	A	C	H	S1
22641-04-04	G1/4**19	6	42.3	5.5	20.2	19
22641-06-05	G3/8**19	8	45.3	6.3	22	22
22641-06-06	G3/8**19	10	46.9	6.3	22.6	22
22641-08-08	G1/2**14	12	61.1	7.5	26.1	27
22641-10-10	G5/8**14	16	72.6	9.5	27.8	30
22641-12-12	G3/4**14	20	79.2	10.9	31.8	32
22641-16-12T	G1**11	20	80.8	11.7	33.4	41
22641-16-16	G1**11	25	88.4	11.7	34.2	41
22641-20-16T	G1.1/4**11	25	85.3	11	31.1	50
22641-20-20W	G1.1/4**11	32	98.8	11	38	50
22641-24-24W	G1.1/2**11	40	116.8	13	45.5	55
22641-32-32W	G2**11	50	135.7	16	52.7	70

Material: Carbon steel #45 / Stainless steel  
Application: Used for 1SN/2SN hose.  
Spiral hose fitting: 22642

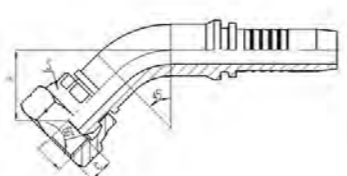

**One Piece fitting 45° BSP FEMALE 60° CONE / ISO 8434-6 / BS 5200 - 22641F**

Part No.	Thread	DN	C	H	S1	S2
22641F-04-04B	G1/4**19	6	5.5	15	17	17
22641F-06-06B	G3/8**19	10	6	17.2	22	19
22641F-08-08B	G1/2**14	12	7	19.3	27	22
22641F-10-10B	G5/8**14	12	8.5	28	27	27
22641F-12-12B	G3/4**14	20	9	29	32	32
22641F-16-16B	G1**11	25	11	34	38	38
22641F-20-20B	G1.1/4**11	32	11	39	50	50
22641F-24-24B	G1.1/2**11	40	12	48	55	55

Material: Carbon steel #45 / Stainless steel  
Application: Used for hose.  
Spiral hose fitting: 22642F

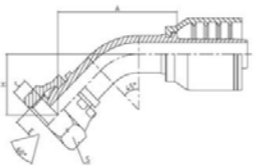

**Interlock 45° BSP FEMALE 60° CONE / ISO 8434-6 / BS 5200 - 22643W**

Part No.	Thread	DN	A	C	H	S2
22643-12-12W	G3/4**14	20	88.3	10.9	32.5	32
22643-16-16W	G1**11	25	99.3	11.7	32.9	41
22643-20-20W	G1.1/4**11	32	112.9	11	37.9	50
22643-24-24W	G1.1/2**11	40	131	13	45.5	55
22643-32-32W	G2**11	50	154.7	16	52.7	70

Material: Carbon steel #45 / Stainless steel  
Application: Used for 4SP/4SH hose.

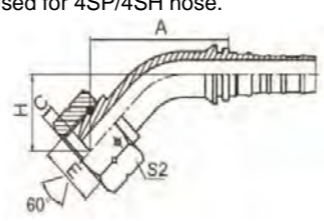

**90° BSP FEMALE 60° CONE / ISO 8434-6 / BS 5200- 22691**

Part No.	Thread	DN	A	C	H	S2
22691-02-03	G1/8**28	5	26.5	5.5	31.5	14
22691-04-03	G1/4**19	5	26.5	5.5	33.5	19
22691-04-04	G1/4**19	6	30	5.5	36.5	19
22691-06-05	G3/8**19	8	33	6.3	40.7	22
22691-06-06	G3/8**19	10	35.3	6.3	43	22
22691-08-08	G1/2**14	12	41	7.5	51	27
22691-10-10	G5/8**14	16	56.5	9.5	56	30
22691-12-12	G3/4**14	20	65.5	10.9	66	32
22691-16-12T	G1**11	20	65.5	11.7	68.3	41
22691-16-16	G1**11	25	76.7	11.7	73.8	41
22691-20-16T	G1.1/4**11	25	78	11	69.5	50
22691-20-20W	G1.1/4**11	32	91.5	11	84.3	50
22691-24-24W	G1.1/2**11	40	109.4	13	103	55
22691-32-32W	G2**11	50	131.8	16	123.3	70

Material: Carbon steel #45 / Stainless steel  
Application: Used for 1SN/2SN hose.  
Spiral hose fitting: 22692

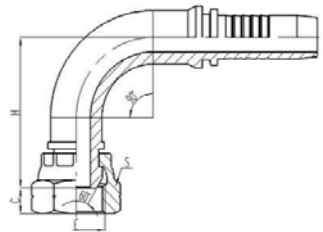

**90° BSP FEMALE 60° CONE DOUBLE HEXAGON / ISO 8434-6 / BS 5200 - 22691K**

Part No.	Thread	DN	A	C	H	S1	S2
22691K-04-04	G1/4**19	6	17.5	5.5	18.5	11	19
22691K-06-04	G3/8**19	6	20	6.3	23	16	22
22691K-06-05	G3/8**19	8	20	6.3	23	16	22
22691K-06-06	G3/8**19	10	20	6.3	24	16	22
22691K-08-06	G1/2**14	10	23	7.5	26.5	19	27
22691K-08-08	G1/2**14	12	23.5	7.5	28.5	19	27
22691K-10-10	G5/8**14	16	25	9.5	29.2	22	30
22691K-12-12	G3/4**14	20	27.5	10.9	33	27	32
22691K-16-16	G1**11	25	32.5	11.7	38.1	33	41

Material: Carbon steel #45 / Stainless steel  
Application: Used for 1SN/2SN hose.

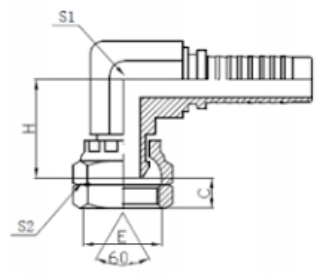

**One piece fitting 90° BSP FEMALE 60° CONE INTEGRAL FITTING / ISO 8434-6 / BS 5200- 22691F**

Part No.	Thread	DN	C	H	S1	S2
22691F-04-04B	G1/4**19	6	5.5	28	17	17
22691F-06-06B	G3/8**19	10	6	36	22	19
22691F-08-08B	G1/2**14	12	7	42	27	22
22691F-12-12B	G3/4**14	20	9	58	32	32
22691F-16-16B	G1**11	25	11	68	38	38
22691F-20-20B	G1.1/4**11	32	11	81.5	50	50
22691F-24-24B	G1.1/2**11	40	12	94	55	55

Material: Carbon steel #45 / Stainless steel  
Application: Used for 1SN/2SN hose.  
Spiral fitting: 22692F

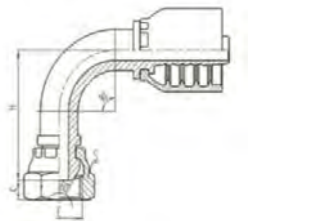

**Interlock 90° BSP FEMALE 60° CONE / ISO 8434-6 / BS 5200 - 22693W**

Part No.	Thread	DN	A	C	H	S2
22693-12-12W	G3/4**14	20	73.8	10.9	67.1	32
22693-16-16W	G1**11	25	91.9	11.7	72	41
22693-20-20W	G1.1/4**11	32	105.8	11	88.3	50
22693-24-24W	G1.1/2**11	40	124.2	13.5	103	55
22693-32-32W	G2**11	50	148.8	16	123.3	70

Material: Carbon steel #45 / Stainless steel  
Application: Used for 4SP/4SH hose.

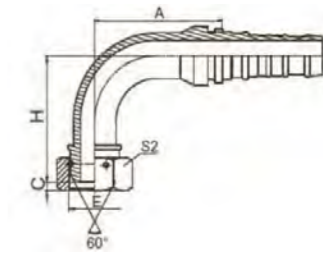





Hose

Ferrule

Fitting JIC

Fitting ORFS

Fitting NPT

Fitting SAE

Fitting BSP

Fitting Flange

Fitting Metric

Fitting JIS

Adapter

Quick Coupling

Camlock

Hose Clamp

Machine

Interlock SAE Flange 6000 PSI / Code 62 Flange - 87613

Table with 7 columns: Part No., Thread, DN, A, C, D, L. Rows include part numbers like 87613-12-12, 87613-16-12, etc.

Material: Carbon steel #45 / Stainless steel
Application: Used for 4SP/SH hose.

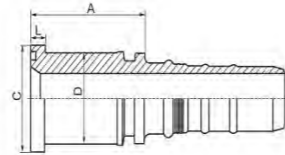

Interlock SAE Flange 6000 PSI / Code 62 Flange 45° - 87643

Table with 8 columns: Part No., Thread, DN, A, C, D, H, L. Rows include part numbers like 87643-12-12, 87643-16-12, etc.

Material: Carbon steel #45 / Stainless steel
Application: Used for 4SP/SH hose.

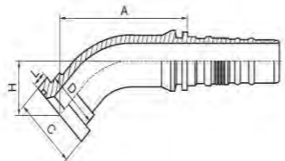

Interlock SAE Flange 6000 PSI / Code 62 Flange 90°Bent - 87693

Table with 8 columns: Part No., Thread, DN, A, C, D, H, L. Rows include part numbers like 87693-12-12, 87693-16-12, etc.

Material: Carbon steel #45 / Stainless steel
Application: Used for 4SP/SH hose.

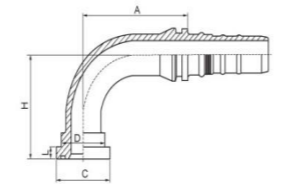

Interlock SAE Flange 6000 PSI Long / Code 62 Flange 45°Bent - 87643H

Table with 8 columns: Part No., Thread, DN, A, C, D, H, L. Rows include part numbers like 87643-16-16(H90), 87643-20-20(H90), etc.

Material: Carbon steel #45 / Stainless steel
Application: Used for 4SP/SH hose.

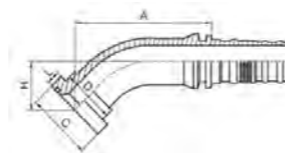

Interlock SAE Flange 6000 PSI Long / Code 62 Flange 90°Bent - 87693H

Table with 8 columns: Part No., Thread, DN, A, C, D, H, L. Rows include part numbers like 87693-16-16(H90), 87693-20-20(H120), etc.

Material: Carbon steel #45 / Stainless steel
Application: Used for 4SP/SH hose.

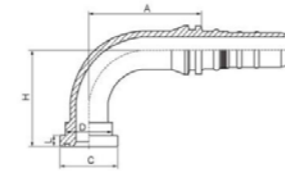

Reusable 90° SAE Flange 6000 PSI For R5 Hose / Code 62 Flange 90°Bent - 87698D-R5

Table with 9 columns: Part No., Thread, DN, A, C, D, H, L, S1. Rows include part numbers like 87698D-08-08(R5), 87698D-12-12(R5), etc.

Material: Carbon steel #45 / Stainless steel
Application: Used for R5 hose.

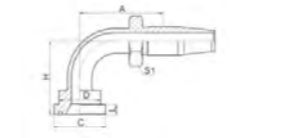

Interlock SAE Flange 9000 PSI / CAT Flange - 87913

Table with 6 columns: Part No., Thread, DN, C, D, L. Rows include part numbers like 87913-08-08, 87913-12-12, etc.

Material: Carbon steel #45 / Stainless steel
Application: Used for 4SP/4SH hose.

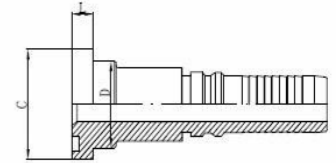

Interlock 45° SAE Flange 9000 PSI / CAT Flange 45°Bent-87943

Table with 7 columns: Part No., Thread, DN, C, D, H, L. Rows include part numbers like 87943-08-08, 87943-12-12, etc.

Material: Carbon steel #45 / Stainless steel
Application: Used for 4SP/4SH hose.

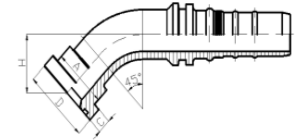

Interlock 90° SAE Flange 9000 PSI / CAT Flange 90°Bent-87993

Table with 7 columns: Part No., Thread, DN, C, D, H, L. Rows include part numbers like 87993-12-12, 87993-16-16, etc.

Material: Carbon steel #45 / Stainless steel
Application: Used for 4SP/4SH hose.

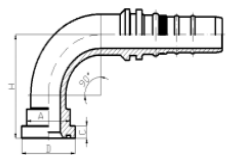

JIS Flange - 88111

Table with 7 columns: Part No., Thread, DN, A, C, D, L. Rows include part numbers like 88111-10-08, 88111-10-10, etc.

Material: Carbon steel #45 / Stainless steel
Application: Used for 1SN/2SN hose.
Spiral fitting: 88112

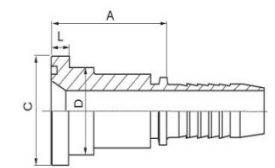

45°JIS Flange -88141

Table with 7 columns: Part No., Thread, DN, A, C, D, H, L. Rows include part numbers like 88141-10-08, 88141-10-10, etc.

Material: Carbon steel #45 / Stainless steel
Application: Used for 1SN/2SN hose.
Spiral fitting: 88142

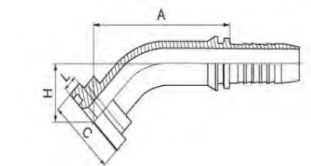

90°JIS Flange -88191

Table with 7 columns: Part No., Thread, DN, A, C, D, H, L. Rows include part numbers like 88191-10-08, 88191-10-10, etc.

Material: Carbon steel #45 / Stainless steel
Application: Used for 1SN/2SN hose.
Spiral fitting: 88192

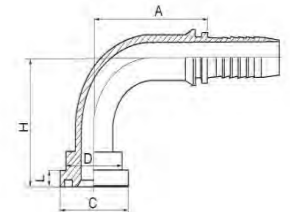

Hose

Ferrule

Fitting JIC

Fitting ORFS

Fitting NPT

Fitting SAE

Fitting BSP

Fitting Flange

Fitting Metric

Fitting JIS

Adapter

Quick Coupling

Camlock

Hose Clamp

Machine









Hose

Ferrule

Fitting JIC

Fitting ORFS

Fitting NPT

Fitting SAE

Fitting BSP

Fitting Flange

Fitting Metric

Fitting JIS

Adapter

Quick Coupling

Camlock

Hose Clamp

Machine

METRIC FEMALE 24° CONE O-RING H.T./ISO12151-2/DIN 3865 - 20511

Table with 7 columns: Part No., Thread, DN, O-RING, A, C, S2. Lists various part numbers and their dimensions.

Material: Carbon steel #45 / Stainless steel
Application: Used for 1SN/2SN hose.
Spiral hose fitting: 20512

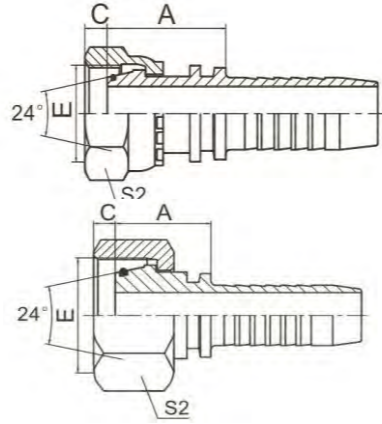

One piece fitting METRIC FEMALE 24° CONE H.T. WITH O-RING ONE TWO-WIRE - 20511F

Table with 5 columns: Part No., Thread, DN, C, S. Lists various part numbers and their dimensions.

Material: Carbon steel #45 / Stainless steel
Application: Used for 1SN/2SN hose.
Spiral hose fitting: 20512F

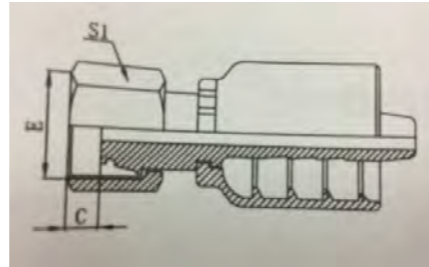

Reusable METRIC FEMALE 24° CONE O-RING H.T. REUSABLE FITTING - 20518D-R5

Table with 5 columns: Part No., Thread, DN, C, S2. Lists various part numbers and their dimensions.

Material: Carbon steel #45 / Stainless steel
Application: Used for R5 hose.

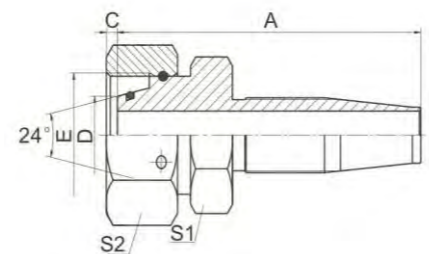

Reusable METRIC FEMALE 24° CONE SEAT WEIGHT - 20518D-R5T

Table with 5 columns: Part No., Thread, DN, C, S1. Lists various part numbers and their dimensions.

Material: Carbon steel #45 / Stainless steel
Application: Used for R5 hose.

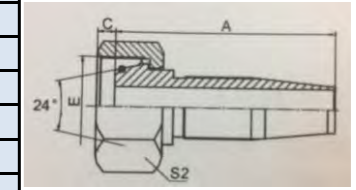

45° METRIC FEMALE 24° CONE O-RING H.T. /ISO12151-2/DIN 3865 - 20541

Table with 8 columns: Part No., Thread, DN, O-RING, A, C, H, S2. Lists various part numbers and their dimensions.

Material: Carbon steel #45 / Stainless steel
Application: Used for 1SN/2SN hose.
Spiral hose fitting: 20542

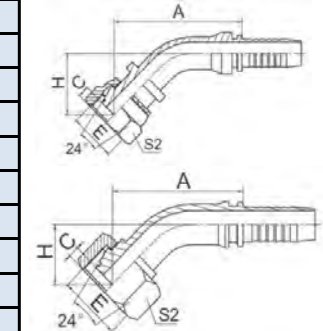

One piece fitting 45° METRIC FEMALE 24° CONE H.T. WITH O-RING ONE TWO-WIRE - 20541F

Table with 6 columns: Part No., Thread, DN, C, H, S1. Lists various part numbers and their dimensions.

Material: Carbon steel #45 / Stainless steel
Application: Used for 1SN/2SN hose.

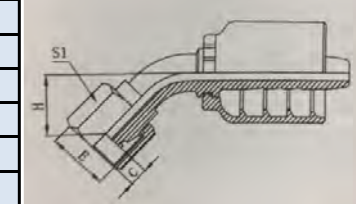

90° METRIC FEMALE 24° CONE O-RING H.T. /ISO12151-2/DIN 3865 - 20591

Table with 8 columns: Part No., Thread, DN, O-RING, A, C, H, S2. Lists various part numbers and their dimensions.

Material: Carbon steel #45 / Stainless steel
Application: Used for 1SN/2SN hose.
Spiral hose fitting: 20592

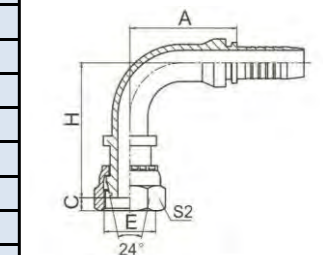

Hose

Ferrule

Fitting JIC

Fitting ORFS

Fitting NPT

Fitting SAE

Fitting BSP

Fitting Flange

Fitting Metric

Fitting JIS

Adapter

Quick Coupling

Camlock

Hose Clamp

Machine

Hose

Ferrule

Fitting JIC

Fitting ORFS

Fitting NPT

Fitting SAE

Fitting BSP

Fitting Flange

Fitting Metric

Fitting JIS

Adapter

Quick Coupling

Camlock

Hose Clamp

Machine

One piece fitting 90° METRIC FEMALE 24° CONE H.T. WITH O-RING ONE TWO-WIRE - 20591F-B

Table with 6 columns: Part No., Thread, DN, C, H, S1. Lists various fitting specifications.

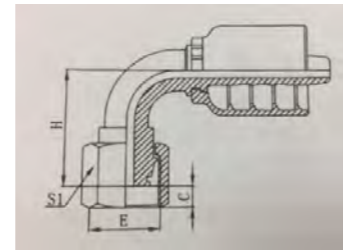

Material: Carbon steel #45 / Stainless steel

Application: Used for 1SN/2SN hose.

Spiral hose fitting: 20592F

Interlock METRIC MALE 24° CONE SEAT H.T. - 10513

Table with 7 columns: Part No., Thread, DN, TUBE O.D, A, C, S2. Lists various fitting specifications.

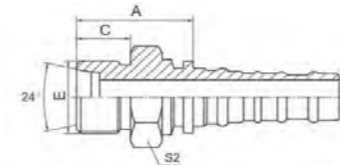

Material: Carbon steel #45 / Stainless steel

Application: Used for 4SP/4SH hose.

Interlock METRIC FEMALE 24° CONE O-RING H.T. ISO 12151-2---DIN3865 -20513W

Table with 8 columns: Part No., Thread, DN, TUBE O.D, O RING, A, C, S2. Lists various fitting specifications.

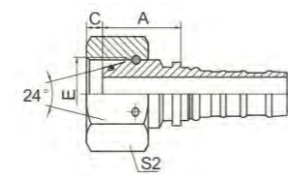

Material: Carbon steel #45 / Stainless steel

Application: Used for 4SP/4SH hose.

Interlock METRIC FEMALE 24° CONE O-RING H.T. ISO 12151-2---DIN3865 - 20513T

Table with 8 columns: Part No., Thread, DN, TUBE O.D, O RING, A, C, S2. Lists various fitting specifications.

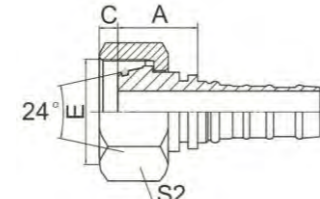

Material: Carbon steel #45 / Stainless steel

Application: Used for 4SP/4SH hose.

Interlock 45°METRIC FEMALE 24° CONE O-RING H.T. -20543T

Table with 9 columns: Part No., Thread, DN, TUBE O.D, O RING, A, C, H, S2. Lists various fitting specifications.

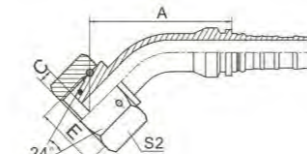

Material: Carbon steel #45 / Stainless steel

Application: Used for 4SP/4SH hose.

Interlock 90°METRIC FEMALE 24° CONE O-RING H.T. - 20543T

Table with 9 columns: Part No., Thread, DN, TUBE O.D, O RING, A, C, H, S2. Lists various fitting specifications.

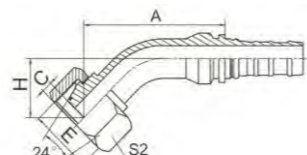

Material: Carbon steel #45 / Stainless steel

Application: Used for 4SP/4SH hose.

Interlock 90°METRIC FEMALE 24° CONE O-RING H.T. - 20593

Table with 9 columns: Part No., Thread, DN, TUBE O.D, O RING, A, C, H, S2. Lists various fitting specifications.

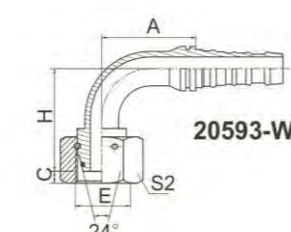

Material: Carbon steel #45 / Stainless steel

Application: Used for 4SP/4SH hose.

METRIC STANDPIPE STRAIGHT DIN 2353

Table with 6 columns: Part No., TUBE O.D, DN, A, C, NOTE. Lists various fitting specifications.

Table with 6 columns: Part No., TUBE O.D, DN, A, C, NOTE. Lists various fitting specifications.

Material: Carbon steel #45 / Stainless steel

Application: Used for R1/R2 hose.

Spiral fitting: 50012

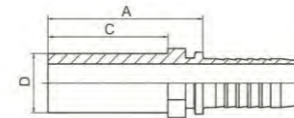

45°METRIC STANDPIPE STRAIGHT DIN 2353

Table with 7 columns: Part No., TUBE O.D, DN, A, C, H, NOTE. Lists various fitting specifications.

Table with 7 columns: Part No., TUBE O.D, DN, A, C, H, NOTE. Lists various fitting specifications.

Material: Carbon steel #45 / Stainless steel

Application: Used for R1/R2 hose.

Spiral fitting: 50042

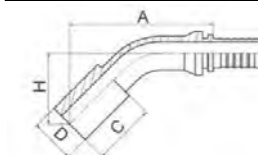

90°METRIC STANDPIPE STRAIGHT DIN 2353

Table with 7 columns: Part No., TUBE O.D, DN, A, C, H, NOTE. Lists various fitting specifications.

Table with 7 columns: Part No., TUBE O.D, DN, A, C, H, NOTE. Lists various fitting specifications.

Material: Carbon steel #45 / Stainless steel

Application: Used for R1/R2 hose.

Spiral fitting: 50092

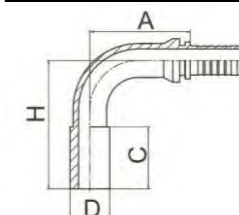

Hose

Ferrule

Fitting JIC

Fitting ORFS

Fitting NPT

Fitting SAE

Fitting BSP

Fitting Flange

Fitting Metric

Fitting JIS

Adapter

Quick Coupling

Camlock

Hose Clamp

Machine

Hose  
 Ferrule  
 Fitting JIC  
 Fitting ORFS  
 Fitting NPT  
 Fitting SAE  
 Fitting BSP  
 Fitting Flange  
 Fitting Metric  
 Fitting JIS  
 Adapter  
 Quick Coupling  
 Camlock  
 Hose Clamp  
 Machine

**GB METRIC MALE 74° CONE /GB T5628 - 10711**

Part No.	Thread	DN	A	C	S1
10711-12-03	M12*1.5	5	26.5	15.7	14
10711-14-04	M14*1.5	6	30.5	18	17
10711-16-05	M16*1.5	8	31.5	19	17
10711-18-06	M18*1.5	10	31.5	19	19
10711-22-08	M22*1.5	12	35	19.5	22
10711-24-08	M24*1.5	12	37	20	24
10711-27-10	M27*1.5	16	38.5	20.5	27
10711-30-12	M30*1.5	20	42.5	23	32
10711-33-12	M33*2	20	45	26	36
10711-36-14	M36*2	22	45	26	38
10711-39-16	M39*2	25	48	27.5	41
10711-42-20	M42*2	32	52	28.5	46
10711-45-20	M45*2	32	52	28.5	46

Material: Carbon steel #45 / Stainless steel  
 Application: Used for 1SN/2SN hose.  
 Spiral hose fitting: 10712

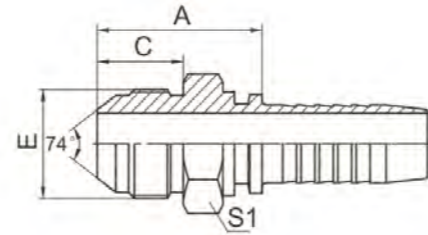

**METRIC FEMALE 74° CONE /GB T9065.1 - 20711**

Part No.	Thread	DN	A	C	S2
20711-12-03	M12*1.5	5	14	10	17
20711-12-04	M12*1.5	6	14.5	10	17
20711-14-04	M14*1.5	6	15.5	8.5	19
20711-16-05	M16*1.5	8	16.5	8	22
20711-18-06	M18*1.5	10	17.5	10	24
20711-20-06T	M20*1.5	10	16	10	24
20711-22-08	M22*1.5	12	18.5	10	27
20711-24-08T	M24*1.5	12	16.5	11	30
20711-27-10T	M27*1.5	16	19.5	11	32
20711-30-12	M30*1.5	20	21.5	11	36
20711-33-12T	M33*2	20	20	13	41
20711-36-14T	M36*2	22	20	14	41
20711-39-16T	M39*2	25	23.5	14	46
20711-42-16T	M42*2	25	23.5	15	50
20711-42-20	M42*2	32	26	15	50
20711-45-20T	M45*2	32	25	15	55
20711-52-24T	M52*2	40	25	17	60

Material: Carbon steel #45 / Stainless steel  
 Application: Used for 1SN/2SN hose.  
 Spiral hose fitting: 20712

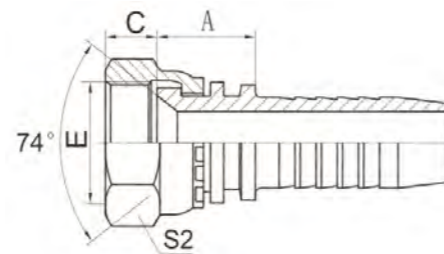

**One piece fitting GB METRIC FEMALE 74° CONE - 20711F**

Part No.	Thread	DN	C	S1	S2
20711F-14-04B	M14*1.5	6	8	17	17
20711F-18-06B	M18*1.5	10	8.5	22	19
20711F-22-08B	M22*1.5	12	10	27	22
20711F-27-10B	M27*1.5	16	10.5	32	27
20711F-30-12B	M30*2	20	11	36	32
20711F-39-16B	M39*2	25	13	46	38

Material: Carbon steel #45 / Stainless steel  
 Application: Used for 1SN/2SN hose.  
 Spiral hose fitting: 20712F

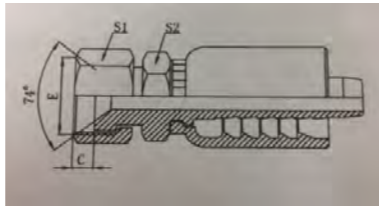

**45° GB METRIC FEMALE 74° CONE SEAT /GB T9065.1L - 20741**

Part No.	Thread	DN	A	C	H	S2
20741-14-04	M14*1.5	6	40.5	8.5	18.5	19
20741-16-05	M16*1.5	8	44.4	8	20	22
20741-18-06	M18*1.5	10	45.7	10	21.4	24
20741-22-08	M22*1.5	12	58.9	10	24	27
20741-27-10	M27*1.5	16	71.2	11	26.4	32
20741-30-12	M30*1.5	20	78.1	11	30	36
20741-33-12	M33*2	20	77.4	13	30	41
20741-36-14	M36*2	22	79.8	14	29.6	41
20741-36-16	M36*2	25	85.7	14	31.5	41
20741-39-16	M39*2	25	86.1	14	31.8	46
20741-45-20	M45*2	32	97	15	36.2	55
20741-52-24	M52*2	40	112.9	17	40.9	60

Material: Carbon steel #45 / Stainless steel  
 Application: Used for 1SN/2SN hose.  
 Spiral hose fitting: 20742

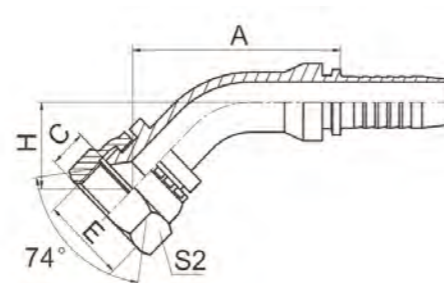

**One piece fitting 45° GB METRIC FEMALE 74° CONE - 20741F**

Part No.	Thread	DN	C	H	S1	S2
20741F-14-04B	M14*1.5	6	8	15	17	17
20741F-16-05B	M16*1.5	8	8	17	19	17
20741F-18-06B	M18*1.5	10	8.5	20	22	19
20741F-22-08B	M22*1.5	12	10	20	27	22
20741F-27-10B	M27*1.5	16	10.5	24	32	27
20741F-30-12B	M30*2	20	11	27	36	32
20741F-39-16B	M39*2	25	13	31.5	46	38

Material: Carbon steel #45 / Stainless steel  
 Application: Used for 1SN/2SN hose.  
 Spiral hose fitting: 20742F

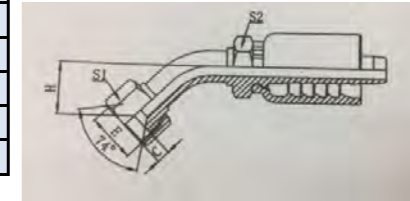

**90° GB METRIC FEMALE 74° CONE SEAT /GB T9065.1 - 20791**

Part No.	Thread	DN	A	C	H	S2
20791-12-04	M12*1.5	6	30	10	33.5	17
20791-14-04	M14*1.5	6	30	8.5	34	19
20791-16-05	M16*1.5	8	34	8	38	22
20791-18-06	M18*1.5	10	35.3	10	41.3	24
20791-22-08	M22*1.5	12	41	10	48	27
20791-27-10	M27*1.5	16	56.5	11	54	32
20791-30-12	M30*1.5	20	66.2	11	63.5	36
20791-33-12	M33*2	20	65.5	13	63.5	41
20791-36-14	M36*2	22	71.2	14	64.5	41
20791-39-16	M39*2	25	76.7	14	70.5	46
20791-45-20	M45*2	32	91.5	15	83	55
20791-52-24	M52*2	40	110.7	17	96.5	60

Material: Carbon steel #45 / Stainless steel  
 Application: Used for 1SN/2SN hose.  
 Spiral hose fitting: 20792

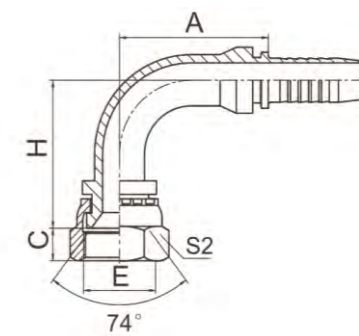

**One piece fitting 90° GB METRIC FEMALE 74° CONE - 20791F**

Part No.	Thread	DN	C	H	S1	S2
20791F-14-04B	M14*1.5	6	8	28	17	17
20791F-18-06B	M18*1.5	10	8.5	36	22	19
20791F-22-08B	M22*1.5	12	10	43	27	22
20791F-27-10B	M27*1.5	16	10.5	55	32	27
20791F-30-12B	M30*2	20	11	58	36	32
20791F-39-16B	M39*2	25	13	68	46	38

Material: Carbon steel #45 / Stainless steel  
 Application: Used for 1SN/2SN hose.  
 Spiral hose fitting: 20792F

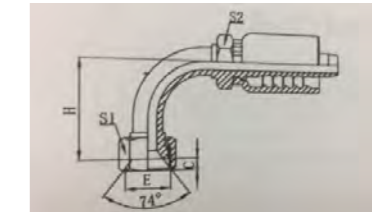

Hose  
 Ferrule  
 Fitting JIC  
 Fitting ORFS  
 Fitting NPT  
 Fitting SAE  
 Fitting BSP  
 Fitting Flange  
 Fitting Metric  
 Fitting JIS  
 Adapter  
 Quick Coupling  
 Camlock  
 Hose Clamp  
 Machine

Hose  
 Ferrule  
 Fitting JIC  
 Fitting ORFS  
 Fitting NPT  
 Fitting SAE  
 Fitting BSP  
 Fitting Flange  
 Fitting Metric  
 Fitting JIS  
 Adapter  
 Quick Coupling  
 Camlock  
 Hose Clamp  
 Machine

**MT Staplelock male - 60011**

Part No.	DN	A	C	J	K
60011-04-04	6	31	25	15	11
60011-05-05	8	33.5	26	18	13
60011-06-06	10	33	26	18	15
60011-08-06	10	33.5	26	22	18
60011-08-08	12	34	26	22	18
60011-10-10	16	39	30	25	20
60011-12-12	20	40.5	31	28	24
60011-16-14	22	41	31	35	30
60011-16-16	25	42	31	35	30

Material: Carbon steel #45 / Stainless steel  
 Application: Used for 1SN/2SN hose.  
 Spiral hose fitting: 60012

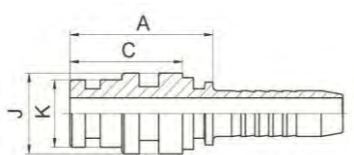

**SAE Staplelock male / SAE J1467**

Part No.	DN	A	C	J	K	O RING
67011-04-04	6	34	28	14.9	9.9	O 06.0*2.0
67011-06-06	10	35	28	19.9	13.9	O 10.0*2.0
67011-08-08	12	36	28	23.9	17.9	O 13.0*2.5
67011-12-12	20	37.5	28	28.9	23.9	O 19.0*2.5
67011-16-16	25	44	33	38.8	30.9	O 25.0*2.5
67011-20-20	32	44	33	45.9	37.9	O 33.0*2.5
67011-24-24	40	47.5	36.3	54.9	46.9	O 40.0*3.0
67011-32-32	50	47.5	36.3	63.9	55.9	O 50.0*3.0

Material: Carbon steel #45 / Stainless steel  
 Application: Used for 1SN/2SN hose.  
 Spiral hose fitting: 60012

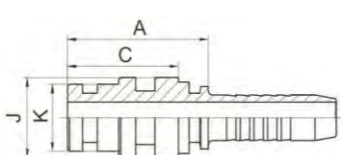

**Double Connector 90011/90012**

Part No.	DN	L
90011-04	6	69
90011-05	8	69
90011-06	10	73
90011-08	12	77
90011-10	16	83
90011-12	20	93
90011-16	25	114
90011-20	32	132
90011-24	40	162
90011-32	50	170

Part No.	DN	L
90012-04	6	83
90012-05	8	87
90012-06	10	87
90012-08	12	91
90012-10	16	97
90012-12	20	110
90012-16	25	134
90012-20	32	153
90012-24	40	172
90012-32	50	178

Material: Carbon steel #45 / Stainless steel  
 Application: Used for 1SN/2SN hose.

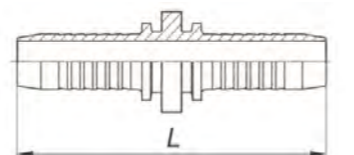

**Metric Banjo DIN 7642 - 70011**

Part No.	Bolt	DN	A	d	D	H
70011-10-03	M10*1	5	14.5	10.1	17	10
70011-10-04	M10*1	6	17	10.1	17	10
70011-12-04	M12*1.5	6	20.5	12.1	20	12
70011-12-05	M12*1.5	8	20.5	12.1	20	12
70011-12-06	M12*1.5	10	20.5	12.1	20	12
70011-14-04	M14*1.5	6	21	14.1	24	14
70011-14-05	M14*1.5	8	21	14.1	24	14
70011-14-06	M14*1.5	10	21	14.1	24	14
70011-16-04	M16*1.5	6	20.5	16.1	28	16
70011-16-05	M16*1.5	8	20.5	16.1	28	16
70011-16-06	M16*1.5	10	20.5	16.1	28	16
70011-18-04	M18*1.5	6	23	18.1	32	20
70011-18-05	M18*1.5	8	24	18.1	32	20
70011-18-06	M18*1.5	10	24	18.1	32	20
70011-18-08	M18*1.5	12	24.5	18.1	32	20
70011-22-06	M22*1.5	10	28.1	22.1	39	25
70011-22-08	M22*1.5	12	28.5	22.1	39	25
70011-22-10	M22*1.5	16	28	22.1	39	25
70011-26-12	M26*1.5	20	32.5	26.1	46	30
70011-30-16	M30*1.5	25	37	30.1	54	36
70011-30-20	M30*1.5	32	40	30.1	54	36

Material: Carbon steel #45 / Stainless steel  
 Application: Used for 1SN/2SN hose.  
 Spiral hose fitting: 70012

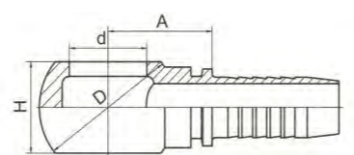

**BSP Banjo - 72011**

Part No.	Bolt	DN	A	d	D	H
72011-02-03	G1/8**28	5	18	9.9	22	16
72011-02-04	G1/8**28	6	18.5	9.9	22	16
72011-04-03	G1/4**19	5	19	13.3	24	15
72011-04-04	G1/4**19	6	19.5	13.3	24	15
72011-04-05	G1/4**19	8	19.5	13.3	24	15
72011-04-06	G1/4**19	10	19.5	13.3	24	15
72011-06-04	G3/8**19	6	22	16.7	29	20
72011-06-05	G3/8**19	8	22	16.7	29	20
72011-06-06	G3/8**19	10	22	16.7	29	20
72011-06-08	G3/8**19	12	23	16.7	29	20
72011-08-05	G1/2**14	8	27.5	21	38	25
72011-08-06	G1/2**14	10	27.5	21	38	25
72011-08-08	G1/2**14	12	28	21	38	25
72011-08-10	G1/2**14	16	29	21	38	25
72011-10-10	G5/8**14	16	28	23	40	27
72011-12-10	G3/4**14	16	32	26.5	48	31
72011-12-12	G3/4**14	20	32	26.5	48	31
72011-16-08	G1**11	12	40	33.3	60	42
72011-16-12	G1**11	20	40	33.3	60	42
72011-16-16	G1**11	25	41	33.3	60	42

Material: Carbon steel #45 / Stainless steel  
 Application: Used for 1SN/2SN hose.  
 Spiral hose fitting: 72012

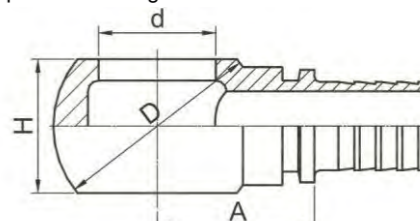

**Metric Bolt DIN7643**

Part No.	Thread	A	B	C	S1
700M-10	M10*1	19	5.5	6	14
700M-12	M12*1.5	24	7	6	17
700M-14	M14*1.5	26	9	6	19
700M-16	M16*1.5	28	11	6	22
700M-18	M18*1.5	32	13	6	24
700M-22	M22*1.5	39	16	7	27
700M-26	M26*1.5	45	20	7	32
700M-30	M30*1.5	51	24	7	36

Material: Carbon steel #45 / Stainless steel  
 Application: Used for 1SN/2SN hose.

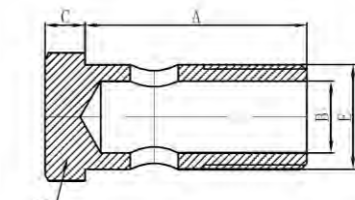

**Bsp Bolt**

Part No.	Thread	A	B	C	S1
720B-02	G1/8**28	29.5	4.8	4.8	14
720B-04	G1/4**19	28.5	6	6	19
720B-06	G3/8**19	38.5	9	7	22
720B-08	G1/2**14	44	13	8.5	27
720B-10	G5/8**14	48.5	15	10	30
720B-12	G3/4**14	56	18	10	32
720B-16	G1**11	68.5	22	13	41

Material: Carbon steel #45 / Stainless steel  
 Application: Used for 1SN/2SN hose.

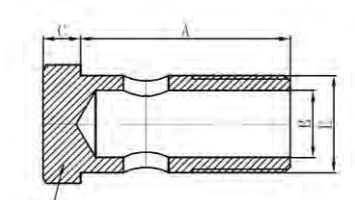

Hose  
 Ferrule  
 Fitting JIC  
 Fitting ORFS  
 Fitting NPT  
 Fitting SAE  
 Fitting BSP  
 Fitting Flange  
 Fitting Metric  
 Fitting JIS  
 Adapter  
 Quick Coupling  
 Camlock  
 Hose Clamp  
 Machine



Hose					
Ferrule	1E Metric Male O-ring	1E9 90° Elbow Metric Male O-ring	AE Metric Male O-ring Tee	XE Metric Male O-ring Cross	2E9 90° Elbow Metric Male O-ring / Female O-ring
Fitting JIC					
Fitting ORFS	BE Metric Male O-ring - Metric Female O-ring Tee	CE 90° Elbow Metric Male O-ring - Metric Female Tee	4E Metric Male O-ring Plug	9E Metric Female O-ring Plug	6E Metric Male O-ring Bulkhead
Fitting NPT					
Fitting SAE	6E9 90° Elbow Metric Male O-ring Bulkhead	AE6EE Metric Male O-ring Bulkhead Branch Tee	AEE6E 90° Metric Male O-ring Bulkhead Run Tee	1EH Metric Male O-ring - Metric Male ISO6149-2	1EH4-OG Metric Male O-ring * Metric Male Adjustable Stud ISO6149-2 (45° Elbow)
Fitting BSP					
Fitting Flange	1EH9-OG Metric Male O-ring * Metric Male Adjustable Stud ISO6149-2 (90° Elbow)	AEEH-OG Metric Male O-ring * Metric Male Adjustable Stud S-series Run Tee	AEHE-OG Metric Male O-ring * Metric Male Adjustable Stud S-series Branch Tee	1EL Metric Male O-ring / Metric Male With Bonded Seal	1EN Metric Male O-ring / NPT Male
Fitting Metric					
Fitting JIS	1ET-SP Metric Male O-ring / BSPT Male	1EW Metric Male O-ring / Butt-Weld Tube	1EW9 90° Elbow Metric Male O-ring / Butt-Weld Tube	1EZ Metric Male O-ring / BSP Male DIN 3852-2 Type A	2WE Butt-weld Tube / Metric Female O-ring
Adapter					
Quick Coupling	1C/1D Metric Male 24° L.T./H.T.	1C/1D Reducer Metric Male 24° L.T./H.T. Reducer	1C9/1D9 90° Elbow Metric Male 24° L.T./H.T.	AC/AD Metric Male 24° L.T./H.T. Tee	XC/XD Metric Male 24° L.T./H.T. Cross
Camlock					
Hose Clamp	2C/2D Metric Female 24° * Metric Male 24° L.T./H.T.	BC/BD Metric Female 24° * Metric Male 24° L.T./H.T. Tee	CC/CD Metric Male 24° * Metric Female 24° L.T./H.T. Tee	3C/3D Metric Female 24° L.T./H.T.	4C/4D Metric Male 24° L.T./H.T. Plug
Machine					



Hose					
Ferrule	9C/9D Metric Female 24° L.T./H.T. Plug	6C/6D Metric Male 24° L.T./H.T. Bulkhead	6C9/6D9 90° Metric Male 24° L.T./H.T. Bulkhead	8C Metric Lock Nut	1CN/1DN Metric Male 24° L.T./H.T. * NPT Male 60°
Fitting JIC					
Fitting ORFS	1CN9/1DN9 Metric Male 24 L.T./H.T. * NPT Male 60° 90° Elbow	1CT-SP/1DT-SP Metric Male 24° L.T./H.T. * BSPT Male 60°	1CT9-SP/1DT9-SP Metric Male 24° L.T./H.T. * BSPT Male 60° 90° Elbow	1CH/1DH Metric Male 24° L.T./H.T. * Metric Male ISO6149-2	1CH4-OG/1DH4-OG Metric Male 24° L.T./H.T. * Metric Male Thread Adjustable Stud Ends ISO6149-2 45° Elbow
Fitting NPT					
Fitting SAE	1CH9-OG/1DH9-OG Metric Male 24° L.T./H.T. * Metric Male Thread Adjustable Stud Ends ISO6149-2 90° Elbow	ACCH-OG/ADDH-OG Metric Male 24° L.T./H.T. * Metric Male Adjustable Stud ISO6149-2 Run Tee	ACHC-OG/ADHD-OG Metric Male 24 L.T./H.T. * Metric Male Adjustable Stud ISO6149-2 Branch Tee	1CG/1DG Metric Male 24° L.T./H.T. * BSP Male With O-ring	1CG4-OG/1DG4-OG Metric Male 24° L.T./H.T. * BSP Thread Adjustable Stud Ends with O-ring Seal 45° Elbow
Fitting BSP					
Fitting Flange	1CG9-OG/1DG9-OG Metric Male 24° L.T./H.T. * BSP Thread Adjustable Stud Ends with O-ring 90° Elbow	ACCG-OG/ADDG-OG Metric Male 24° L.T./H.T. * BSP Male Adjustable Stud Run Tee	ACGC-OG/ADGD-OG Metric Male 24° L.T./H.T. * BSP Male Adjustable Stud Branch Tee	1CO/1DO Metric Male 24° L.T./H.T. * SAE Male O-ring	1CO9-OG/1DO9-OG Metric Male 24° L.T./H.T. * SAE Male Adjustable Stud 90° Elbow
Fitting Metric					
Fitting JIS	ACCO-OG/ADDO-OG Metric Male 24° L.T./H.T. * SAE Male Adjustable Stud Run Tee	ACOC-OG/ADOD-OG Metric Male 24° L.T./H.T. * SAE Male Adjustable Stud Branch Tee	1CB/1DB Metric Male 24° L.T./H.T. * BSP Male Double 60° Seat Bonded Seal	1CB9-OG/1DB9-OG Metric Male 24° L.T./H.T. * BSP Male Double 60° Seat Bonded Seal 90° Elbow	1CB-WD/1DB-WD Metric Male 24° L.T./H.T. * BSP Thread With Captive Seal
Adapter					
Quick Coupling	2BC-WD/2BD-WD Metric Female 24° L.T./H.T. * BSP Male Double 60° Seat Bonded Seal	1CM/1DM Metric Male 24° L.T./H.T. * 60° Cone Bonded Seal	1CM-WD/1DM-WD Metric Male 24° L.T./H.T. * 60° Cone Captive Seal	2MC-WD/2MD-WD Metric Female 24° Cone O-ring L.T./H.T. * Metric Thread	1CJ/1DJ Metric Male 24° L.T./H.T. * JIC 74° Cone Seal
Camlock					
Hose Clamp	2JC/2JD JIC 74° * Metric Female 24° O-ring Sealing L.T./H.T.	1CW/1DW Metric Male 24° L.T./H.T. * Weld Fitting	2GC/2GD Metric Female 24° L.T./H.T. Cone O-ring * BSP Male O-ring	5CB/5DB Metric Male 24° L.T./H.T. * BSP Female	5CM/5DM Metric Male 24° L.T./H.T. * Metric Female
Machine					





Hose					
Ferrule	NL/NS Retaining Nut L.T. /H.T.	RL/RS Cutting Ring L.T. /H.T.	1Q Metric Male 74° Cone	AQ Metric Male 74° Cone Tee	2Q9 Metric Male 74° cone * Metric Female 74° Seat 90° Elbow
Fitting JIC					
Fitting ORFS	4Q Metric Male 74° Cone Plug	6Q Metric Male 74° Cone Bulkhead	6Q9 90° Metric Male 74° Cone Bulkhead	1QH Metric 74° Cone *Metric Male	1QH9-OG Metric 74° Cone *Metric Male Adjustable Stud 90° Elbow
Fitting NPT					
Fitting SAE	AQHQ Metric Male 74° Cone *Adjustable Stud Branch Tee	AQQH Metric Male 74° Cone *Adjustable stud Run Tee	1QG Metric Male 74° Cone *BSP Male O-ring	1QG9-OG Metric Male 74° Cone *BSP Male O-ring Adjustable Stud 90° Elbow	1QO Metric Male 74° Cone *SAE Male O-ring
Fitting BSP					
Fitting Flange	1QO9-OG Metric Male 74° Cone *SAE Male O-ring Adjustable Stud 90° Elbow	1QN Metric Male 74° Cone *NPT Male	1QN4 Metric Male 74° Cone *NPT Male 45° Elbow	1QN9 Metric Male 74° Cone *NPT Male 90° Elbow	1QT-SP Metric Male 74° Cone *BSPT Male
Fitting Metric					
Fitting JIS	1QT9-SP Metric Male 74° Cone *BSPT Male 90° Elbow	1QB Metric Male 74° Cone *BSP Male Double for 60° Seat Bonded Seal	NB200-Q Metric Male 74° Cone Flare Nut GB/T5647	NB500-Q Metric Male 74° Cone Flare Sleeve GB/T5646	1K JIS Metric Male 60° Cone
Adapter					
Quick Coupling	AK JIS Metric Male 60° Cone Tee	2K9 JIS Metric Male 60° Cone *JIS Metric Female 60° 90° Elbow	BK JIS Metric Male 60° Cone *JIS Metric Female 60° Cone Seat Branch Tee	CK JIS Metric Male 60° cone-JIS Metric Female 60° seat run Tee	4K JIS Metric Male 60° Cone Plug
Camlock					
Hose Clamp	9K JIS Metric Female 60° Seat Plug	1KH JIS Metric Male 60° Cone *Metric Male S Series	1KH9-OG JIS Metric Male 60° Cone *Metric Male Adjustable Stud 90° Elbow	AKHK-OG JIS Metric Male 60° Cone *Adjustable Stud Branch Tee	AKKH-OG JIS Metric Male 60° Cone *Adjustable Stud Run Tee
Machine					











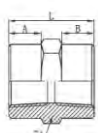
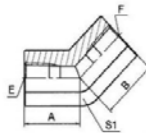
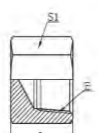
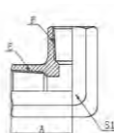
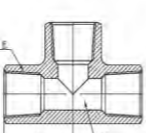
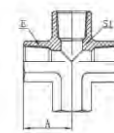
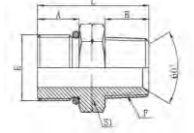
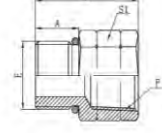
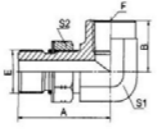

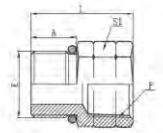
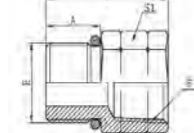
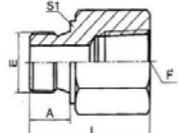
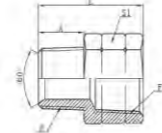
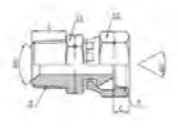
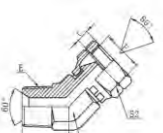
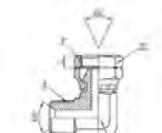
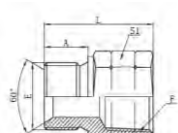
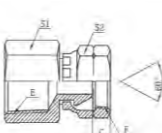
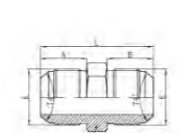

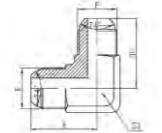
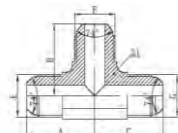
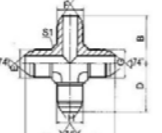
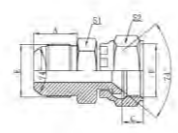
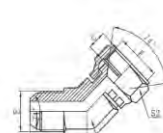
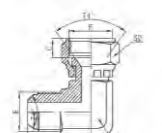
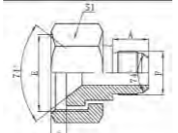
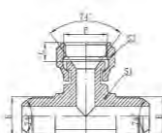
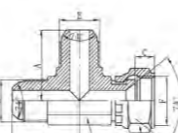
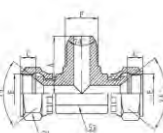
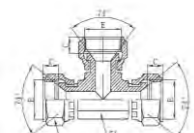
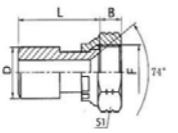
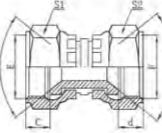
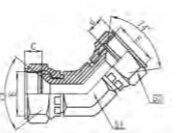

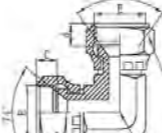
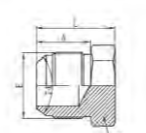
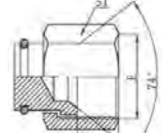
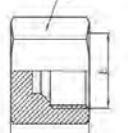
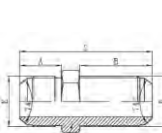

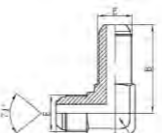
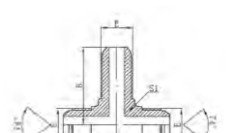
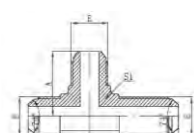
Hose					
Ferrule	1KG JIS Metric Male 60° Cone *BSP Male O-ring	1KG9-OG JIS Metric Male *BSP Male O-ring Adjustable Stud 90° Elbow	AKGK-OG JIS Metric Male *BSP Male O-ring Adjustable Stud Branch Tee	AKKG-OG JIS Metric Male *BSP Male O-ring Adjustable Stud Tee	1KT-SP JIS Metric Male 60° Cone *BSPT Male
Fitting JIC					
Fitting ORFS	1S JIS Gas Male 60° Cone	BS JIS Gas Male 60° Cone *JIS Gas Female 60° Seat Branch Tee	CS JIS Gas Male 60° Cone *JIS Gas Female 60° Seat Run Tee	4S JIS Gas Male 60° Cone Plug	9S JIS Gas Female 60° Cone Plug
Fitting NPT					
Fitting SAE	6S JIS Gas Male 60° Cone Bulkhead	1SG JIS Gas Male 60° Cone *BSP Male O-ring	1SG9-OG JIS Gas Male 60° Cone *BSP Male O-ring Adjustable Stud 90° Elbow	ASGS-OG JIS Gas Male 60° Cone *BSP Male O-ring Adjustable Stud Seat Branch Tee	ASSG-OG JIS Gas Female 60° Cone *BSP Male O-ring Adjustable Stud End Run Tee
Fitting BSP					
Fitting Flange	1ST-SP JIS Gas Male 60° Cone *BSPT Male	1ST4-SP JIS Gas Male 60° Cone *BSPT Male 45° Elbow	1ST9-SP JIS Gas Male 60° Cone *BSPT Male 90° Elbow	DS JIS Gas Female 60° Seat Tee	AS JIS Gas Male 60° Seat Tee
Fitting Metric					
Fitting JIS	1B BSP Male Double For 60° Seat Bonded Seal	1B9 BSP Male 60° Seat 90° Elbow	AB BSP Male 60° Seat Tee	2B BSP Male Double for 60° Seat Bonded Seal *BSP Female 60° Cone	2B4 BSP Male 60° Seat *BSP Female 60° Cone 45° Elbow
Adapter					
Quick Coupling	2B9 BSP Male 60° Seat *BSP Female 60° Cone 90° Elbow	BB BSP Male 60° Seat *BSP Female 60° Cone Branch Tee	CB BSP Male 60° Seat *BSP Female 60° Cone Run Tee	3B BSP Female 60° Cone	3B9 BSP Female 60° Cone 90° Elbow
Camlock					
Hose Clamp	3B4 BSP Female 60° Cone 45° Elbow	DB BSP Female 60° Cone Tee	4B BSP Male Double for 60° Seat or Bonded Seal Plug	9B BSP Female 60° Cone Plug	6B BSP Male 60° Seat Bulkhead
Machine					

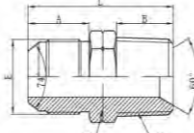

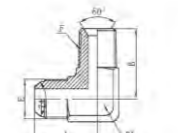
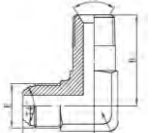
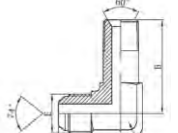
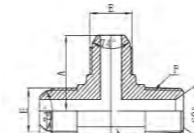
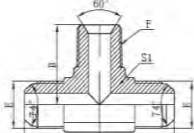
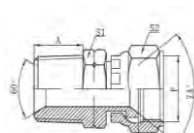

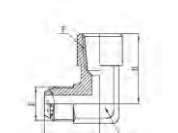
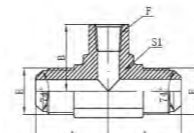
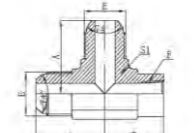
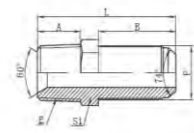
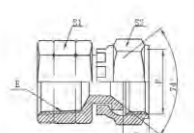
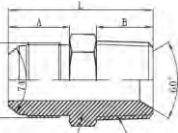

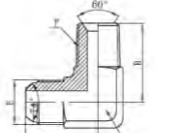
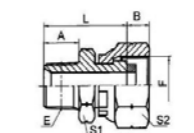

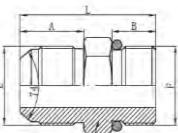
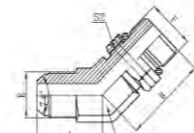
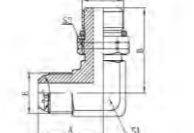
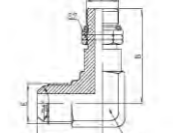
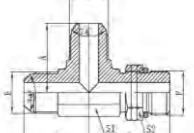
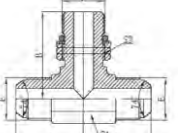

Hose					
Ferrule	6B9 BSP Male 60° Seat Bulkhead 90° Elbow	8B BSP Lock Nut	1BT-SP BSP Male Double for 60° Seat Bonded Seal * BSPT Male	1BT4-SP BSP Male 60° Seat *BSPT Male 45° Elbow	1BT9-SP BSP Male 60° Seat *BSPT Male 90° Elbow
Fitting JIC					
Fitting ORFS	1BN BSP Male Double for 60° Seat Bonded Seal * NPT Male	1BN9 BSP Male 60° Seat * NPT Male 90° Elbow	1BN4 BSP Male 60° Seat * NPT Male 45° Elbow	1BG BSP Male Double for 60° Seat Bonded Seal * BSPT Male O-ring	1BG4-OG BSP Male 60° Seat * BSP Male O- ring Adjustable Stud End 45° Elbow
Fitting NPT					
Fitting SAE	1BG9-OG BSP Male 60° Seat * BSP Male O- ring Adjustable Stud End 90° Elbow	ABBG-OG BSP Male 60° Seat * BSP Male O- ring Adjustable Stud End Run Tee	ABGB-OG BSP Male 60° Seat * BSP Male O- ring Adjustable Stud End Branch Tee	1BH BSP Male Double for 60° Seat Bonded Seal * Metric Male L-Series	1BH4-OG BSP Male 60° Seat * Metric Male O-ring 45° Elbow
Fitting BSP					
Fitting Flange	1BH9-OG BSP Male 60° Seat * Metric Male O-ring 90° Elbow	1BJ BSP Male Double for 60° Seat Bonded Seal * JIC Male 74° Cone.	1BJ9 BSP Male 60° Seat * JIC Male 74° Cone 90° Elbow	2BJ BSP Male Double for 60° Seat Bonded Seal * JIC Female 74° Seat	1BL BSP Male Double use for 60° seat or Bonded seal/ Metric male with bonded seal
Fitting Metric					
Fitting JIS	1BM BSP Male 60° Seat Adjustable Double 60° Seat Bonded Seal * Metric Male Double 60° Seat Bonded Seal	1BO BSP Male 60° Seat Bonded Seal * SAE O-ring Boss L-Series	1BW BSP Male 60° Seat Bonded Seal * Butt-Weld Tube	2WB Butt-Weld Tube * BSP Female 60° Cone	1B-WD BSP Male 60° Seat Bonded Seal * BSP Male Captive Seal
Adapter					
Quick Coupling	2BJ-WD BSP Male Double for 60° Seat Bonded Seal * JIC Female 74° Seat	2NB NPT Male * BSP Female 60° Cone	2NB9 NPT Male * BSP Female 60° Cone 90° Elbow	2NB4 NPT Male * BSP Female 60° Cone 45° Elbow	2TB-SP BSPT Male * BSP Female 60° Cone
Camlock					
Hose Clamp	2TB9-SP BSPT Male * BSP Female 60° Cone 90° Elbow	2TB4-SP BSPT Male * BSP Female 60° Cone 45° Elbow	4BN BSP Male Captive Hollow Plug	4BN-WD BSP Male Captive Seal Hollow Hex Plug	4B-WD BSP Male Captive Seal Plug
Machine					

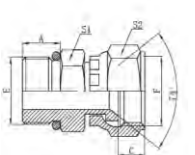
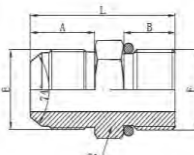
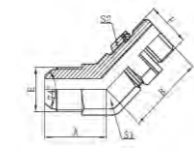
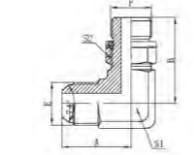
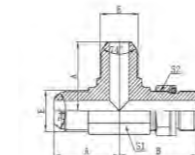
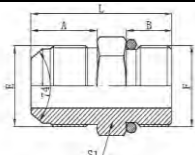
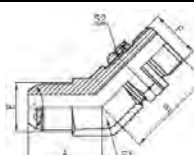
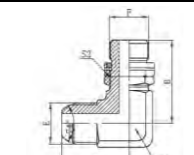
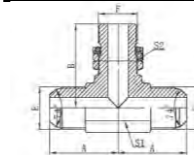
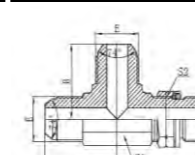
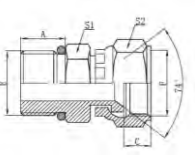
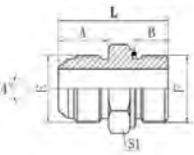
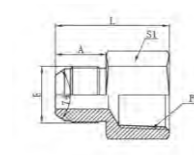
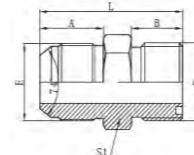
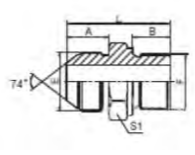
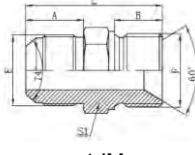

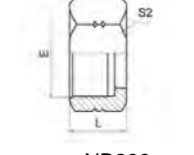
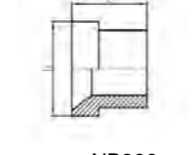

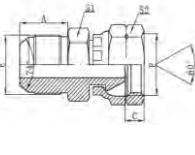
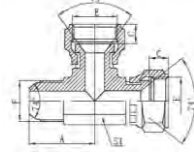

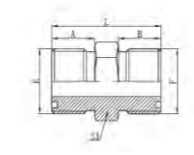
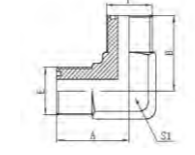
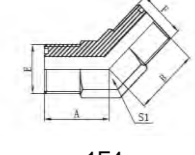
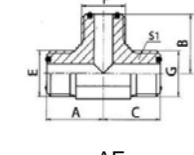
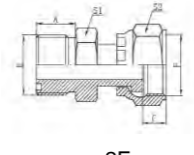

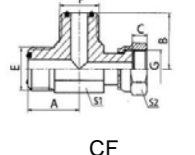
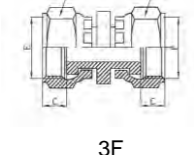
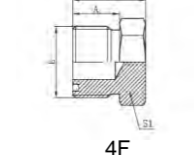
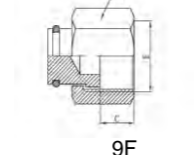
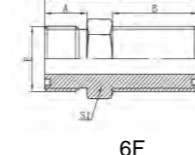

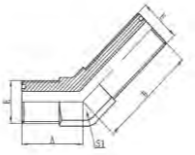
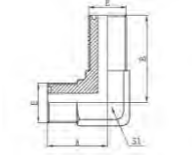
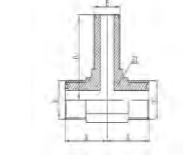
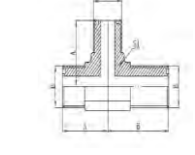
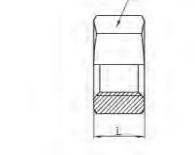
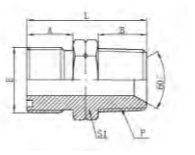

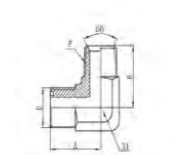
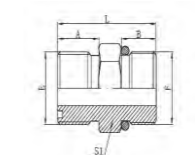

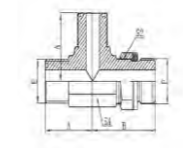
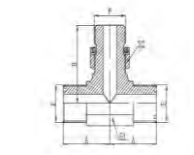
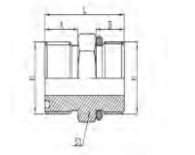
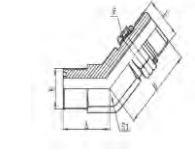
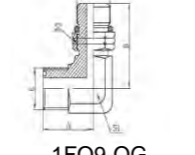
Hose					
Ferrule	5B BSP Male Double for 60° Seat Bonded Seal * BSP Female	5B9 BSP Male 60° Seat * BSP Female 90° Elbow	7B BSP Female	7B9-PK BSP Female 90° Elbow	GB-PK BSP Female Tee
Fitting JIC					
Fitting ORFS	5BN BSP Male Double for 60° Seat Bonded Seal * NPT Female	5BT BSP Male Double for 60° Seat Bonded Seal * BSPT Female	5B-WD BSP Male Captive Seal * BSP Female	5GB BSP Male O-ring * BSP Female	7TB-S BSPT Female * BSP Female 60° Cone
Fitting NPT					
Fitting SAE	2B-G BSP Male Double for 60° Seat Bonded Seal * BSP Female 60° Cone	2B9-G BSP Male 60° Seat * BSP Female 60° Cone 90° Elbow	2TB-G/SP BSPT Male * BSP Female 60° Cone	5B-G BSP Male Double for 60° Seat Bonded Seal * BSP Female	1T-SP BSPT Male
Fitting BSP					
Fitting Flange	1T9-SP BSPT Male 90° Elbow	4T-SP BSPT Male Plug	4TN BSPT Male Hollow Hex Plug	5T-SP BSPT Male * BSPT Female	5T9-SP BSPT Male * BSPT Female 90° Elbow
Fitting Metric					
Fitting JIS	7T BSPT Female	7T9-SP BSPT Female 90° Elbow	GT-PK BSPT Female Tee	ZT BSPT Female Cross	5GT BSP Male O-ring * BSPT Female
Adapter					
Quick Coupling	1N NPT Male	1N9 NPT Male 90° Elbow	AN NPT Male Tee	4N NPT Male Plug	4NN NPT Male Hollow Hex Plug
Camlock					
Hose Clamp	5N NPT Male * NPT Female	5N4 NPT Male * NPT Female 45° Elbow	5N9 NPT Male * NPT Female 90° Elbow	JN NPT Female * NPT Male Branch Tee	HN NPT Female * NPT Male Run Tee
Machine					

Hose					
Ferrule	7N NPT Female	7N4-PK NPT Female 45° Elbow	9N-CAP NPT Female Plug	7N9-PK NPT Female 90° Elbow	GN-PK NPT Female Tee
Fitting JIC					
Fitting ORFS	ZN NPT Female Cross	1NO NPT Male * SAE O-ring Boss	5ON SAE O-ring Boss L-series * NPT Female	5ON9-OG 90° ELBOW SAE O-RING BOSS L-SERIES ISO 11926-3 / NPT FEMALE	5NO NPT Male * SAE Female
Fitting NPT					
Fitting SAE	5GN BSP Male O-ring * NPT Female	5HN Metric Male L-Series * NPT Female	5LN METRIC MALE WITH BONDED SEAL / NPT FEMALE	5TN-SP BSPT Male * NPT Female	2NU NPT Male * NPSM Female 60° Cone
Fitting BSP					
Fitting Flange	2NU4 NPT Male * NPSM Female 60° Cone 45° Elbow	2NU9 NPT Male * NPSM Female 60° Cone 90° Elbow	5MN Metric Male with Bonded Seal * NPT Female	7NU NPT Female * NPSM Female 60° Cone	1J/2403 JIC Male 74° Cone
Fitting Metric					
Fitting JIS	1J4/2504 JIC Male 74° Cone 45° Elbow	1J9/2500 JIC Male 74° cone 90° Elbow	AJ/2603 JIC Male 74° Cone Tee	XJ JIC MALE 74° CONE CROSS	2J/6504 JIC Male 74° Cone * JIC Female 74° Seat
Adapter					
Quick Coupling	2J4/6502 JIC Male 74° Cone * JIC Female 74° Seat 45° Elbow	2J9/6500 JIC Male 74° Cone * JIC Female 74° Seat 90° Elbow	5J-S JIC Male * JIC Female	BJ/6600 JIC Male 74° Cone * JIC Female Branch Tee	CJ/6602 JIC Male 74° Cone * JIC Female 74° Seat Run Tee
Camlock					
Hose Clamp	EJ/6603 JIC Female 74° Seat * JIC Male 74° Cone Branch Tee	DJ/6606 JIC Female 74° Seat Tee	2WJ BUTT-WELD TUBE / JIC FEMALE 74° SEAT	3J/6565 JIC Female 74° Seat	3J4 JIC Female 74° Seat 45° Elbow
Machine					

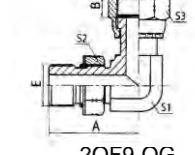
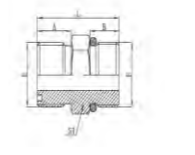
Hose					
Ferrule	3J9 JIC Female 74° Seat 90° Elbow	4J/2408 JIC Male 74° Cone Plug	9J JIC Female 74° Seat Plug	9J-CAP/0304-C JIC 74° Female Plug/CAP	6J/2700 JIC Male 74° Cone Bulkhead
Fitting JIC					
Fitting ORFS	6J4/2702 45° JIC Male 74° Cone Bulkhead	6J9/2701 90° JIC Male 74° Cone Bulkhead	AJ6JJ/2703 JIC Male 74° Cone Bulkhead Branch Tee	AJJ6J/2704 JIC Male 74° Cone Bulkhead Run Tee	8J JIC Lock Nut
Fitting NPT					
Fitting SAE	1JN JIC Male 74° Cone * NPT Male	1JN4 JIC Male 74° Cone * NPT Male 45° Elbow	1JN9 JIC Male 74° Cone * NPT Male 90° Elbow	1JN9-L JIC Male 74° Cone * Long NPT Male 90° Elbow	1JN9-LL JIC Male 74° Cone * Longer NPT Male 90° Elbow
Fitting BSP					
Fitting Flange	AJJN JIC Male 74° Cone * NPT Male Run Tee	AJNJ JIC Male 74° Cone * NPT Male Branch Tee	2NJ NPT Male * JIC Female 74° Seat	5JN JIC Male 74° Cone * NPT Female	5JN9 JIC Male 74° Cone * NPT Female 90° Elbow
Fitting Metric					
Fitting JIS	KJNJ JIC Male 74° Cone * NPT Female Branch Tee	LJJN JIC Male 74° Cone * NPT Female Run Tee	6NJ NPT Male * JIC Male 74° Cone Bulkhead	7NJ-S NPT Female * JIC Female 74° Seat	1JT-SP JIC Male 74° Cone * BSPT Male
Adapter					
Quick Coupling	1JT4-SP JIC Male 74° Cone * BSPT Male 45° Elbow	1JT9-SP JIC Male 74° Cone * BSPT Male 90° Elbow	2TJ-SP BSPT MALE / JIC FEMALE 74° SEAT	5JT JIC Male 74° Cone * BSPT Female	1JO JIC Male 74° Cone * SAE O-ring Boss
Camlock					
Hose Clamp	1JO4-UG JIC Male 74° Cone * SAE O-ring Boss 45° Elbow	1JO9-OG JIC Male 74° Cone * SAE O-ring Boss 90° Elbow	1JO9-UGL JIC Male 74° Cone * Long SAE O-ring Boss 90° Elbow	AJJO-OG JIC Male 74° Cone * SAE O-ring Boss Run Tee	AJOJ-OG JIC Male 74° Cone * SAE O-ring Boss Branch Tee
Machine					

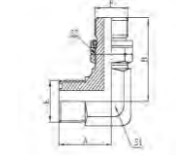
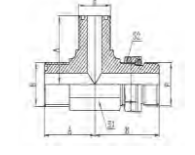
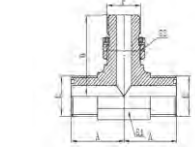
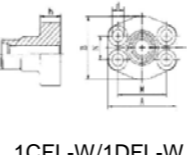
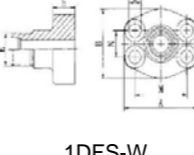
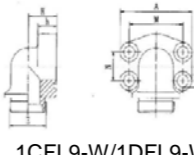
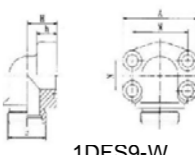
Hose
Ferrule
Fitting JIC
Fitting ORFS
Fitting NPT
Fitting SAE
Fitting BSP
Fitting Flange
Fitting Metric
Fitting JIS
Adapter
Quick Coupling
Camlock
Hose Clamp
Machine

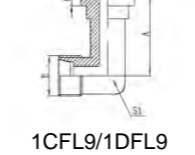
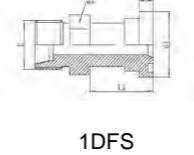
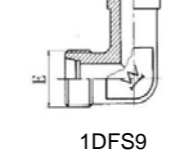
Hose					
Ferrule	20J SAE O-ring Boss * JIC Female 74° Seat	1JH JIC Male 74° Cone * Metric Male End O-ring	1JH4-OG JIC Male 74° Cone * Metric Male Adjustable Stud End 45° Elbow	1JH9-OG JIC Male 74° Cone * Metric Male Adjustable Stud End 90° Elbow	AJJH-OG JIC Male 74° Cone * Metric Male Adjustable Stud End
Fitting JIC					
Fitting ORFS	1JG JIC Male 74° Cone * BSP Male O-ring	1JG4-OG JIC Male 74° Cone * BSP Male O-ring 45° Elbow	1JG9-OG JIC Male 74° Cone * BSP Male O-ring 90° Elbow	AJGJ-OG JIC Male 74° Cone * BSP Male O-ring Branch Tee	AJJG-OG JIC Male 74° Cone * BSP Male O-ring Run Tee
Fitting NPT					
Fitting SAE	2GJ BSP Male O-ring * JIC Female 74° Cone	1JB-WD BSP Male Captive Seal * JIC Male 74° Cone	5JB JIC Male 74° Cone * BSP Female	1JF JIC Male 74° Cone * ORFS Male	1JL JIC Male 74° cone / Metric male with bonded seal
Fitting BSP					
Fitting Flange	1JM JIC Male 74° Cone * Metric Male Double for 60° Seat or Bonded Seal	1JM-WD JIC Male 74° Cone * Metric Male Captive Seal	NB200 JIC Flare Tube End Nut	NB300 JIC Inch Sleeve	NB500 JIC Metric Sleeve
Fitting Metric					
Fitting JIS	2JB JIC Male 74° Cone * BSP Female 60° Cone	FJ JIC Female 74° Seat * JIC Male 74° Cone Branch Tee	00TSUM-NB JIC Flare Tube End Nut	1F ORFS Male O-ring	1F9 ORFS Male O-ring 90° Elbow
Adapter					
Quick Coupling	1F4 ORFS Male O-ring 45° Elbow	AF ORFS MALE O-RING TEE	2F ORFS Male O-ring * ORFS Female	2F4 ORFS Male O-ring * ORFS Female 45° Elbow	2F9 ORFS Male O-ring * ORFS Female 90° Elbow
Camlock					
Hose Clamp	CF ORFS MALE O-RING / ORFS FEMALE RUN TEE	3F ORFS Female	4F ORFS Male O-ring Plug	9F ORFS Female Plug	6F ORFS Male O-ring Bulkhead

Hose					
Ferrule	6F4 45° ORFS Male O-ring Bulkhead	6F9 90° ORFS Male O-ring Bulkhead	AF6FF ORFS Male O-ring Bulkhead Branch Tee	AFF6F ORFS Male O-ring Bulkhead Run Tee	8F ORFS Lock Nut
Fitting JIC					
Fitting ORFS	1FN ORFS Male O-ring * NPT Male	1FN4 ORFS Male O-ring * NPT Male 45° Elbow	1FN9 ORFS Male O-ring * NPT Male 90° Elbow	1FH ORFS Male O-ring * Metric Male O-ring	1FH4-OG ORFS Male O-ring * Metric Male Adjustable Stud End 45° Elbow
Fitting NPT					
Fitting SAE	1FH9-OG ORFS Male O-ring * Metric Male Adjustable Stud End 90° Elbow	AFFH-OG ORFS Male O-ring * Metric Male Adjustable Stud End Run Tee	AFHF-OG ORFS Male O-ring * Metric Male Adjustable Stud End Branch Tee	1FO ORFS Male O-ring * SAE O-ring Boss S-series	1FO4--OG ORFS Male O-ring * SAE O-ring Boss S-series 45° Elbow
Fitting BSP					
Fitting Flange	1FO9-OG ORFS Male O-ring * SAE O-ring Boss S-series 90° Elbow	AFFO-OG ORFS Male O-ring * SAE O-ring Boss Run Tee	AFOF-OG ORFS Male O-ring * SAE O-ring Boss Branch Tee	2OF SAE O-ring Boss S-series * ORFS Female	2OF9-OG 90° ELBOW SAE O-RING BOSS S- SERIES ISO 11926-2 / ORFS FEMALE
Fitting Metric					
Fitting JIS	1FG ORFS Male O-ring * BSP Male O-ring	1FG4-OG ORFS Male O-ring * BSP Male O-ring 45° Elbow	1FG9-OG ORFS Male O-ring * BSP Male O-ring 90° Elbow	AFFG-OG ORFS Male O-ring * BSP Male O-ring Run Tee	AFGF-OG ORFS Male O-ring * BSP Male O-ring Run Tee
Adapter					
Quick Coupling	1CFL-W/1DFL-W SAE FLANGE WITH STANDARD SERIES	1DFS-W SAE FLANGE WITH HIGH PRESSURE SERIES	1CFL9-W/1DFL9-W 90° ELBOW SAE FLANGE WITH STANDARD SERIES	1DFS9-W 90° ELBOW SAE FLANGE WITH HIGH PRESSURE SERIES	1CFL/1DFL Metric Male Bite Type * L- series Flange
Camlock					
Hose Clamp	1CFL9/1DFL9 Metric Male Bite Type * L- series Flange 90° Elbow	1DFS Metric Male Bite Type * S- series Flange	1DFS9 Metric Male Bite Type * S- series Flange 90° Elbow	1FFL ORFS Male O-ring * L- series Flange	1FFL9 ORFS Male O-ring * L- series Flange 90° Elbow

Hose					
Ferrule	1FFS ORFS Male O-ring * S-series Flange	1FFS9 ORFS Male O-ring * S-series Flange 90° Elbow	1JFL JIC Male 74° Cone * L-series Flange	1JFL4 JIC Male 74° Cone * L-series Flange 45° Elbow	1JFL9 JIC Male 74° Cone * L-series Flange 90° Elbow
Fitting JIC					
Fitting ORFS	1JFS JIC Male 74° Cone * S-series Flange	1JFS4 JIC Male 74° Cone * S-series Flange 45° Elbow	1JFS9 JIC Male 74° Cone * S-series Flange 90° Elbow	1FSW S-series Flange - Butt Weld Tube	1FLW L-series Flange - Butt Weld Tube
Fitting NPT					
Fitting SAE	FL L-series Split Flange Clamps	FS S-series Split Flange Clamps	FL-W L-series Whole Flange Clamps	FS-W S-series Whole Flange Clamps	4FL L-series Flange Plug
Fitting BSP					
Fitting Flange	4FS S-series Flange Plug	4FL-M L-series Flange Plug	4FS-M S-series Flange Plug	1G BSP Male O-ring	4G BSP Male O-ring Plug
Fitting Metric					
Fitting JIS	1GT BSP Male O-ring * BSPT Male	4HN Metric Male L-series Hollow Hex Plug	1H Metric Male L-series	4H Metric Male L-series Plug	1M Metric Male Double for 60° Cone Seat Bonded Seal
Adapter					
Quick Coupling	4M Metric Male Double for 61° Cone Seat Bonded Seal Plug	4M-WD Metric Male Captive Seal Hollow Hex Plug	1O SAE O-ring Boss	1OT SAE O-ring Boss * BSPT Male	2OU/6901 SAE O-ring Boss -NPSM Female 60° Cone
Camlock					
Hose Clamp	4O SAE O-ring Boss Plug	4UN SAE O-ring Boss Hollow Hex Plug	1P SAE Male 90° Cone	4P SAE Male 90° Cone Plug	2404 Male JIC to NPTF Male Pipe
Machine					



Hose					
Ferrule	2405 Male JIC to NPTF Female Pipe	2501 Male JIC to Male NPTF 90° Elbow	2502 Male JIC to NPTF Female Pipe 90° Elbow	2503 Male JIC to NPTF Male Pipe 45° Elbow	2505 Male JIC to NPTF Female pipe 45° Elbow
Fitting JIC					
Fitting ORFS	2601 Male JIC / Male JIC to NPTF Male Pipe Branch Tee	2602 Male JIC/ Male JIC to NPTF Female Pipe Branch Tee	2605 Male JIC/ Male JIC to NPTF Male Pipe Run Tee	2606 Male JIC/ Male JIC to NPTF Female Pipe Run Tee	2607 Male JIC/Male JIC to NPTF Male Pipe Branch Tee
Fitting NPT					
Fitting SAE	2608 Male JIC/ NPTF Female Pipe to NPTF Male Pipe Branch Tee	2609 Male JIC/ NPTF Female Pipe to NPTF Female Pipe Branch Tee	2610 NPTF Male Pipe / Male Pipe to Male JIC Branch Tee	2611 Male JIC/ NPTF Male pipe to NPTF Female Pipe Branch Tee	2612 NPTF Female Pipe / Female Pipe to Male JIC Branch Tee
Fitting BSP					
Fitting Flange	2613 NPTF Male Pipe/ Female Pipe to Male JIC Branch Tee	2651 Male JIC/ Male JIC / Male JIC/ NPTF Male Pipe Cross	2653 Male JIC/ NPTF Male Pipe/ Male JIC/ NPTF Male Pipe Cross	2705 Male JIC/ Bulkhead to NPTF Female Pipe	2706 Male JIC Bulkhead to NPTF Male Pipe
Fitting Metric					
Fitting JIS	3474 Male Adjustable O-ring Boss to Male O-ring Boss	6400 Male JIC to Male O-ring	6503 NPTF Female Pipe to Female JIC Swivel 90° Elbow	6505 NPTF Male Pipe to Female JIC Swivel	6506 NPTF Female Pipe to Female JIC Swivel
Adapter					
Quick Coupling	6505 NPTF Male Pipe to Female JIC Swivel	6805 Male O-ring to NPTF Female Pipe 90° Elbow	6805L Long Male O-ring to Female NPTF Pipe	6806 Male O-ring to Male Pipe 90° Elbow	6807 Male Adjustable O-ring to Male Adjustable O-ring 90° Elbow
Camlock					
Hose Clamp	6809 Male O-ring to Female JIC Swivel 90° Elbow	6815 Male O-ring to Female O-ring 90° Elbow	5000 NPTF Female Hex NPTF Female Pipe	5404 NPTF Male Pipe Hex NPTF Male Pipe	5405 NPTF Male Pipe to NPTF Female Pipe
Machine					



Hose					
Ferrule	5406 NPTF Hex Reducer Bushing	5406P NPTF Hex Head Pipe Plug	5500 NPTF Male Pipe to NPTF Male Pipe 90° Elbow	5501 NPTF Male Pipe to NPTF Male Pipe 45° Elbow	5502 NPTF Male Pipe to NPTF Female Pipe 90° Elbow
Fitting JIC					
Fitting ORFS	5503 NPTF Male Pipe to NPTF Female Pipe 45° Elbow	5504 NPTF Female Pipe to NPTF Female Pipe 90° Elbow	5505 NPTF Female Pipe to NPTF Female Pipe 45° Elbow	5600 NPTF Male Pipe / NPTF Male Pipe / NPTF Male Pipe Union Tee	5601 NPTF Male Pipe / NPTF Male Pipe to NPTF Female Pipe Branch Tee
Fitting NPT					
Fitting SAE	5602 NPTF Female Pipe / NPTF Female Pipe to Male Pipe Run Tee	5603 NPTF Male Pipe / NPTF Male Pipe to NPTF Female Pipe Run Tee	5604 NPTF Female Pipe / NPTF Female Pipe to NPTF Male Pipe Branch Tee	5605 NPTF Female Pipe / NPTF Female Pipe / NPTF Female Pipe Union Tee	5650 NPTF Male Pipe / NPTF Male Pipe / NPTF Male Pipe Cross
Fitting BSP					
Fitting Flange	5652 NPTF Female / NPTF Female / NPTF Female / NPTF Female Pipe Cross	5653 NPTF Female Pipe / NPTF Male Pipe / Female Pipe / Male Pipe Cross	5655 NPTF Female Pipe / Female Pipe / NPTF Male Pipe / NPTF Female Pipe Cross	6404 Female O-ring to NPTF Male Pipe	6405 Male O-ring to NPTF Female Pipe
Fitting Metric					
Fitting JIS	6408 Male O-ring to Hex Head plug	6410 Male O-ring to Female O-ring	1404 NPTF Male Pipe to Female Pipe Swivel	1405 NPTF Female Pipe to Female Pipe Swivel	1501 NPTF Male Pipe to Female Pipe Swivel 90° Elbow
Adapter					
Quick Coupling	1502 NPTF Female Pipe to Female Pipe Swivel 90° Elbow	1503 NPTF Male Pipe to Female Pipe Swivel 45° Elbow	1504 NPTF Female Pipe to Female Pipe Swivel 45° Elbow	1601 NPTF Female Swivel / Female Pipe Swivel to Male Pipe Branch Tee	1602 NPTF Female Swivel pipe / Female Pipe Swivel to Female Pipe Branch Tee
Camlock					
Hose Clamp	1603 NPTF Female Swivel pipe / Female Pipe Swivel to Female Pipe Swivel Union Tee	6901 Male O-ring to Female Pipe Swivel 90° Elbow	6902 Male O-ring to Female Pipe Swivel 45° Elbow		
Machine					

One Touch Push-In Fitting (PT,R,NPT)				
Male straight <b>PC</b>	Round Male straight <b>POC</b>	Female Straight <b>PCF</b>	Male Elbow <b>PL</b>	Female Elbow <b>PLF</b>
Extended Male Elbow <b>PLL</b>	Male Branch Tee <b>PT</b>	Female Branch Tee <b>PTF</b>	Male Run Tee <b>PST</b>	Male Y <b>PWT</b>
Male Triple Union <b>PKB</b>	Male Triple Branch Reducer <b>PKD</b>	Male Banjo <b>PH</b>	Female Banjo <b>PHF</b>	Bulkhead Female Straight <b>PMF</b>

One Touch Push-In Fitting (UNITE,PLUG)				
Union Straight <b>PUC</b>	Union Reducer <b>PG</b>	Union Elbow <b>PUL</b>	Union Tee <b>PUT</b>	Union Tee Reducer <b>PTG</b>
Union Reducer <b>PTW</b>	Union Y <b>PY</b>	Union Y Reducer <b>PW</b>	Union Cross <b>PZA</b>	Union Triple Reducer Branch <b>PKG</b>
Bulkhead Union <b>PMM</b>	Bulkhead Elbow <b>PLM</b>	Plug <b>PP</b>	Plug-In Elbow <b>PLJ</b>	Plug-In Reducer <b>PGJ</b>
Triple Branch Union <b>PK</b>	Plug-In Y <b>PYJ</b>	Plug-In Reducer Y <b>PWJ</b>	Union Reducer <b>PXJ</b>	Plug-In Triple Branch Union <b>PKJ</b>



















One Touch Push-In Fitting With O-ring(BSPP,G)				
Male Straight <b>PC-G</b>	Female Straight <b>PCF-G</b>	Round Male Straight <b>POC-G</b>	Bulkhead Female Straight <b>PMF-G</b>	Male Elbow <b>PL-G</b>

























Hose					
Ferrule	Female Elbow <b>PLF-G</b>	Extended Male Elbow <b>PLL-G</b>	Male Branch Tee <b>PT-G</b>	Female Branch Tee <b>PTF-G</b>	Male Run Tee <b>PST-G</b>
Fitting JIC					
Fitting ORFS	Male Banjo <b>PH-G</b>	Female Banjo <b>PHF-G</b>	Male Y <b>PWT-G</b>	Male Triple <b>PXT-G</b>	Male Triple Branch Union <b>PKB-G</b>
Fitting NPT					
Fitting SAE	Male Triple Branch Reducer <b>PKD</b>				
Fitting BSP	<b>Compact One Touch Push-In Fitting</b>				
Fitting Flange					
Fitting Metric	Male Straight <b>PC-C</b>	Round Male Straight <b>POC-C</b>	Male Elbow <b>PL-C</b>	Extended Male Elbow <b>PLL-C</b>	Male Branch Tee <b>PT-C</b>
Fitting JIS					
Adapter	<b>All Brass One Touch Fitting (PT,R,NPT)</b>				
Quick Coupling					
Camlock	Male Straight <b>MPC</b>	Round Male Straight <b>MPOC</b>	Female Straight <b>MPCF</b>	Male Elbow <b>MPL</b>	Extended Male Elbow <b>MPLL</b>
Hose Clamp					
Machine	Female Elbow <b>MPLF</b>	Male Branch Tee <b>MPT</b>	Male Run Tee <b>MPST</b>	Male Y <b>MPWT</b>	Bulkhead Female Straight <b>MPMF</b>

<b>All Brass One Touch Fitting (PT,R,NPT)</b>				
Male Banjo <b>MPH</b>	Female Banjo <b>MPHF</b>	Double Male Banjo <b>MDPH</b>	Triple Male Banjo <b>MTPH</b>	Male Banjo <b>MPK</b>
Double Male Banjo <b>MDPK</b>	Triple Male Banjo <b>MTPK</b>			

<b>All Brass One Touch Fitting (UNITE,PLUG)</b>				
Union Straight <b>MPUC</b>	Union reducer <b>MPG</b>	Bulkhead Union <b>MPMM</b>	Union Elbow <b>MPUL</b>	Union Tee <b>MPUT</b>
Union Tee Reducer <b>MPTG</b>	Plug <b>MPP</b>	Plug-In Reducer <b>MPGJ</b>	Union Y <b>MPY</b>	Union Cross <b>MPZA</b>
Plug-In Elbow Reducer <b>MPLGJ</b>	Plug-In Elbow <b>MPLJ</b>			

<b>All Brass One Touch Push-In Fitting With O-ring(BSPP,G)</b>				
Male Straight <b>MPC-G</b>	Female Straight <b>MPCF-G</b>	Round Male Straight <b>MPOC-G</b>	Male Elbow <b>MPL-G</b>	Female Elbow <b>MPLF-G</b>

	<b>All Brass One Touch Push-In Fitting With O-ring(BSP,G)</b>				
Hose					
Ferrule	Extended Male Elbow <b>MPLL-G</b>	Male Branch Tee <b>MPT-G</b>	Male Run Tee <b>PST-G</b>	Male Y <b>MPX</b>	Male Banjo <b>MPH-G</b>
Fitting JIC					
Fitting ORFS	Double Male Banjo <b>MDPH-G</b>	Triple Male Banjo <b>MTPH-G</b>	Female Banjo <b>MPHF-G</b>	Male Banjo <b>MPK-G</b>	Double Male Banjo <b>MDPK-G</b>
Fitting NPT					
Fitting SAE	Triple Male Banjo <b>MTPK-G</b>				
Fitting BSP	<b>Stainless Steel One Touch Fitting</b>				
Fitting Flange					
Fitting Metric	Male Straight <b>MPCS</b>	Male Elbow <b>MPLS</b>	Male Branch Tee <b>MPTS</b>	Male Banjo <b>MPHFS</b>	Union Straight <b>MPUCS</b>
Fitting JIS	Union Elbow <b>MPUCS</b>		Union Tee <b>MPUTS</b>		
Adapter	Union Elbow <b>MPULS</b>	Female Straight <b>MPCFS</b>		Union Straight <b>MPMS</b>	
Quick Coupling	Union Elbow <b>MPUCS</b>	Union Elbow <b>MPULS</b>	Union Tee <b>MPUTS</b>	Female Straight <b>MPCFS</b>	Union Straight <b>MPMS</b>
	<b>Compact One Touch Push-In Fitting</b>				
Camlock					
Hose Clamp	JSC	JSC-G	PA		
Machine					

	<b>Compact One Touch Push-In Fitting</b>				
Hose					
Ferrule	Tube-Tube <b>HVFF</b>	Thread-Thread <b>HVSS</b>	Tube-Thread <b>HVFS</b>	Thread-Tube <b>HVSF</b>	
Fitting JIC	<b>Silencers</b>				
Fitting ORFS					
Fitting NPT	Standard Silencer <b>BSL</b>	Flat Silencer <b>BSLM</b>	D Type Series Silencer <b>BSLD</b>	C Type Exhaust Silencer <b>BESLC</b>	B Type Exhaust Silencer <b>BESL</b>
Fitting SAE	<b>Hydraulic Quick Coupling</b>				
Fitting BSP					
Fitting Flange	Flat Face Hydraulic Quick Coupling ISO16028 <b>QKEP</b>	Flat Face Hydraulic Quick Coupling ISO16028 <b>QKFH</b>	Flat Face Hydraulic Quick Coupling ISO16028 <b>QKPS</b>	Flat Face Hydraulic Quick Coupling <b>KDF</b>	Thread To Connect Under Pressure Couplings(Brace) <b>QKTF</b>
Fitting Metric					
Fitting JIS	Thread Locked Type Hydraulic Coupling <b>QKTL</b>	Thread Locked Type Hydraulic Coupling <b>KVV</b>	Thread Locked Type Hydraulic Coupling <b>KCV</b>	Thread Locked Type Hydraulic Coupling <b>KGW</b>	Thread Locked Type Hydraulic Coupling <b>KSG</b>
Adapter					
Quick Coupling	Thread Locked Type Hydraulic Coupling <b>KVS</b>	Thread Locked Type Hydraulic Coupling <b>KSN</b>	Mold Coolant-Line Quick Coupling <b>PC</b>	Straight Through Coupling <b>ST</b>	Garden Hose Coupling <b>GH</b>
Camlock					
Hose Clamp	Hydraulic Check Valve <b>KVU</b>				
Machine					



Hose  
 Ferrule  
 Fitting JIC  
 Fitting ORFS  
 Fitting NPT  
 Fitting SAE  
 Fitting BSP  
 Fitting Flange  
 Fitting Metric  
 Fitting JIS  
 Adapter  
 Quick Coupling  
 Camlock  
 Hose Clamp  
 Machine

**Pneumatic Single Shut-Off Universal Series (ARO, TRU-FLATE, INDUSTRIAL INTERCHANGE)**



USF USM

**Pneumatic Single Shut-Off A Series/ ARO 210 INTERCHANGE**



ASF ASM ASH ASFA



ASMA ASHA APF APM APH

**Pneumatic Single Shut-Off I Series/ INDUSTRIAL INTERCHANGE**

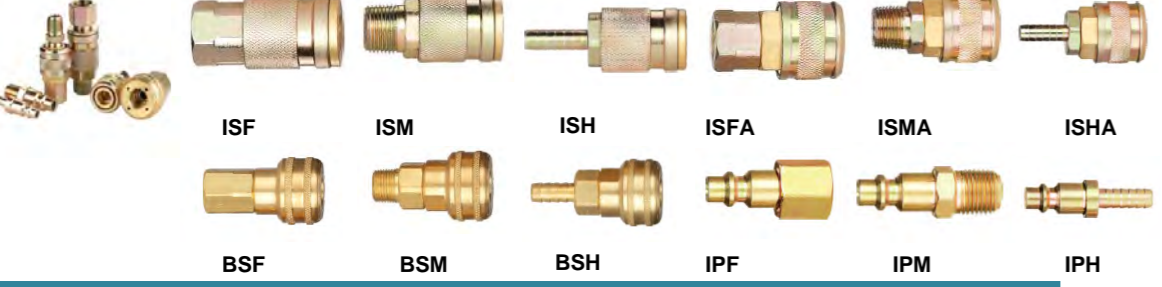

ISF ISM ISH ISFA ISMA ISHA

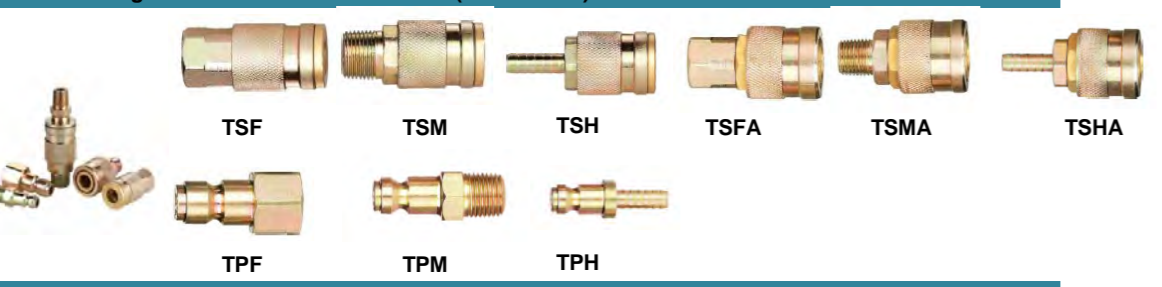

BSF BSM BSH IPF IPM IPH

**Pneumatic Single Shut-Off T Series/ PARKER (TRU-FLATE) INTERCHANGE**

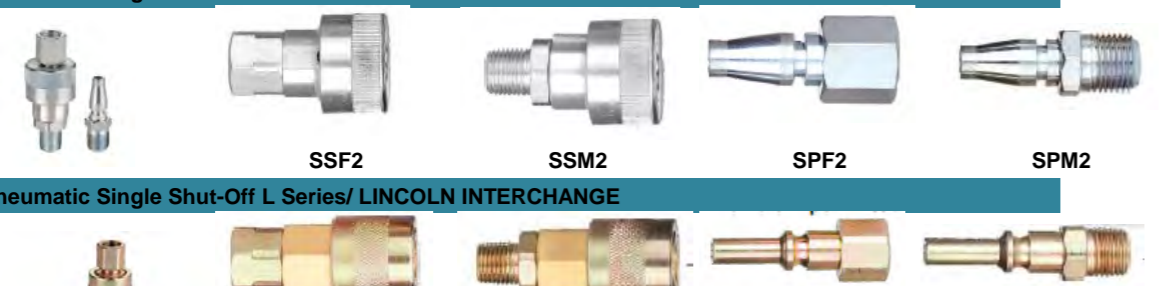

TSF TSM TSH TSFA TSMA TSHA



TPF TPM TPH

**Pneumatic Single Shut-Off S Series/ SCHRADER INTERCHANGE**



SSF2 SSM2 SPF2 SPM2

**Pneumatic Single Shut-Off L Series/ LINCOLN INTERCHANGE**



LSF2 LSM LPF LPM

**Pneumatic Single Shut-Off D Series/ RECTUS 21 INTERCHANGE**



DSF DSM DSH  
 DPF DPM DPH

**ISO 7241 A SERIES HYDRAULIC QUICK COUPLINGS (STAINLESS STEEL)**

Standard:ISO 7241A  
 Part No.:KZE/KZEB  
 Thead: NPT /BSP  
 Material:Carbon Steel  
 Nipple: KZE  
 Steel Ball: KZEB



PART NO.	THREAD		FLOW RATE	W.P.(Mpa/PSI)	B.P.(Mpa/PSI)
	BSP	NPT			
KZE/KZEB-02	G1/4	Z1/4	9 (2.4)	35 (5000)	140(21000)
KZE/KZEB-03	G3/8	Z3/8	30(7.9)	30 (4500)	140(21000)
KZE/KZEB-04	G1/2	Z1/2	75 (19.8)	30 (4500)	130(19500)
KZE/KZEB-06	G3/4	Z3/4	180 (47.6)	30 (4500)	120(18000)
KZE/KZEB-08	G1	Z1	270 (71.4)	25 (3625)	100(14500)
KZE/KZEB-10	G1-1/4	Z1-1/4	330 (87.3)	25 (3625)	100(14500)
KZE/KZEB-12	G1 1/2	Z1-1/2	450 (119)	20 (3000)	80(12000)
KZE/KZEB-16	G2	Z2	900 (238)	15 (2250)	60(9000)

**ISO 7241 A SERIES HYDRAULIC QUICK COUPLINGS (STEEL)/STEEL BALL**



Standard:ISO 7241A  
 Part No.:KZESS  
 Thead: NPT /BSP  
 Material:Stainless steel

PART NO.	THREAD		FLOW RATE	W.P.(Mpa/PSI)	B.P.(Mpa/PSI)
	BSP	NPT			
KZESS-02	G1/4	Z1/4	14 (3.08)	35 (5075)	200(29000)
KZESS-03	G3/8	Z3/8	27(5.9)	27 (3900)	160(23200)
KZESS-04	G1/2	Z1/2	60 (15.9)	32 (4625)	130(18850)
KZESS-06	G3/4	Z3/4	110 (29.1)	25 (3750)	165(24000)
KZESS-08	G1	Z1	150 (39.7)	21 (3025)	106(15350)
KZESS-12	G1 1/2	Z1-1/2	750 (198.4)	14 (2025)	60(8700)
KZESS-16	G2	Z2	1600 (423.3)	9 (1300)	45(6525)

**ISO 7241 B SERIES HYDRAULIC QUICK COUPLINGS (STEEL)/STEEL BALL**

Standard:ISO 7241B  
 Part No.:KZB  
 Thead: NPT /BSP  
 Material: Carbon Steel



PART NO.	THREAD		FLOW RATE	W.P.(Mpa/PSI)	B.P.(Mpa/PSI)
	BSP	NPT			
KZB-01	G1/8	Z1/8	5(1.3)	50(7500)	200(30000)
KZB-02	G1/4	Z1/4	17 (4.5)	45 (6750)	200(30000)
KZB-03	G3/8	Z3/8	50(13.2)	30 (4500)	120(18000)
KZB-04	G1/2	Z1/2	75 (19.8)	35 (5250)	140(21000)
KZB-06	G3/4	Z3/4	190 (50.2)	25 (3625)	100(14500)
KZB-08	G1	Z1	270 (71.4)	30 (4500)	120(18000)
KZB-12	G1 1/2	Z1-1/2	750 (198.4)	14 (2100)	56(8400)
KZB-16	G2	Z2	1600 (423.3)	9 (1350)	40(6000)

Hose  
 Ferrule  
 Fitting JIC  
 Fitting ORFS  
 Fitting NPT  
 Fitting SAE  
 Fitting BSP  
 Fitting Flange  
 Fitting Metric  
 Fitting JIS  
 Adapter  
 Quick Coupling  
 Camlock  
 Hose Clamp  
 Machine



Hose  
 Ferrule  
 Fitting JIC  
 Fitting ORFS  
 Fitting NPT  
 Fitting SAE  
 Fitting BSP  
 Fitting Flange  
 Fitting Metric  
 Fitting JIS  
 Adapter  
 Quick Coupling  
 Camlock  
 Hose Clamp  
 Machine

**ISO 7241 B SERIES HYDRAULIC QUICK COUPLINGS BRASS**

Standard:ISO 7241B  
 Part No.:KZD  
 Thead: NPT /BSP  
 Material: Brass



PART NO.	THREAD		FLOW RATE	W.P.(Mpa/PSI)	B.P.(Mpa/PSI)
	BSP	NPT			
KZD-01	G1/8	Z1/8	6(1.6)	22(3175)	150(21750)
KZD-02	G1/4	Z1/4	16 (4.2)	20 (2900)	120(17400)
KZD-03	G3/8	Z3/8	25(6.6)	15 (2175)	100(14500)
KZD-04	G1/2	Z1/2	60 (15.9)	17 (2450)	90(13050)
KZD-06	G3/4	Z3/4	110 (29.0)	10 (1450)	102(14775)
KZD-08	G1	Z1	150 (39.6)	14 (2025)	80(11600)
KZD-12	G1 1/2	Z1-1/2	750 (198.4)	7 (1000)	40(5800)
KZD-16	G2	Z2	1600 (423.3)	6 (850)	31(4475)

**ISO 7241 B SERIES HYDRAULIC QUICK COUPLINGS STAINLESS STEEL**



Part No.:KZBSS  
 Thead: NPT /BSP  
 Material:Stainless steel

PART NO.	THREAD		FLOW RATE	W.P.(Mpa/PSI)	B.P.(Mpa/PSI)
	BSP	NPT			
KZBSS-02	G1/4	Z1/4	14 (3.08)	35 (5075)	200(29000)
KZBSS-03	G3/8	Z3/8	27(5.9)	27 (3900)	160(23200)
KZBSS-04	G1/2	Z1/2	60 (15.9)	32 (4625)	130(18850)
KZBSS-06	G3/4	Z3/4	110 (29.1)	25 (3750)	165(24000)
KZBSS-08	G1	Z1	150 (39.7)	21 (3025)	106(15350)
KZBSS-12	G1 1/2	Z1-1/2	750 (198.4)	14 (2025)	60(8700)
KZBSS-16	G2	Z2	1600 (423.3)	9 (1300)	45(6525)

**DOUBLE SHUT-OFF COUPLINGS WITH HARDEND STEEL POPPETS**

Double Shut-off Couplings with hardend Steel poppets  
 Standard:ISO 7241-2  
 Part No.: KPC  
 Thead: NPT /BSP  
 Material: Carbon steel



PART NO.	THREAD		FLOW RATE	W.P.(Mpa/PSI)	B.P.(Mpa/PSI)
	BSP	NPT			
KPC-02	G1/4	Z1/4	15 (3.9)	35 (5000)	140(20000)
KPC-03	G3/8	Z3/8	50(13.2)	30 (4500)	120(17400)
KPC-04	G1/2	Z1/2	75 (19.8)	30 (4500)	120(17400)
KPC-06	G3/4	Z3/4	150 (39.6)	30 (4500)	120(17400)
KPC-08	G1	Z1	230 (60.8)	25 (3625)	100(14500)

**PUSH AND PULL TYPE HYDRAULIC QUICK COUPLINGS STEEL**



Push and pull type hydraulic couplings  
 Standard:ISO 7241-2  
 Part No.: KZA  
 Thead: NPT /BSP  
 Material: Carbon steel

PART NO.	THREAD		FLOW RATE	W.P.(Mpa/PSI)	B.P.(Mpa/PSI)
	BSP	NPT			
KZA-03	G3/8	Z3/8	24(6.2)	27 (3800)	110(15700)
KZA-04	G1/2	Z1/2	75 (19.8)	30 (4300)	120(17100)
KZA-08	G1	Z1	270 (71.4)	22 (3150)	90(12900)

**PUSH AND PULL TYPE HYDRAULIC QUICK COUPLINGS STEEL**

Push and pull type hydraulic couplings  
 Standard:ISO 7241-2  
 Part No.: KZAF/KZAV  
 Thead: NPT /BSP  
 Material: Carbon steel



PART NO.	THREAD		FLOW RATE	W.P.(Mpa/PSI)	B.P.(Mpa/PSI)
	BSP	NPT			
KZAF/KZAV-04	G1/2	Z1/2	68 (18)	25 (3625)	105(15250)

**AMERICAN TYPE HYDRAULIC COUPLINGS**

Standard:ISO 7241-2  
 Part No.: KNV  
 Thead: NPT /BSP  
 Material: Carbon steel

Standard:ISO 7241-2  
 Part No.: KNV  
 Thead: NPT /BSP  
 Material: Carbon steel



PART NO.	THREAD		FLOW RATE	W.P.(Mpa/PSI)	B.P.(Mpa/PSI)
	BSP	NPT			
KNV-02	G1/4	Z1/4	22 (5.81)	27 (3915)	110(15950)
KNV-03	G3/8	Z3/8	65(17.17)	30 (4350)	120(17400)
KNV-04	G1/2	Z1/2	75 (19.82)	22 (3190)	88(12760)
KNV-06	G3/4	Z3/4	170 (44.91)	19 (2755)	76(11020)
KNV-08	G1	Z1	280 (73.98)	15 (2175)	60(8700)
KNV-10	G1-1/4	Z1-1/4	450 (118.89)	10 (1450)	50(7250)
KNV-12	G1 1/2	Z1-1/2	450 (118.89)	11 (1595)	45(6525)
KNV-16	G2	Z2	1100 (290.62)	10 (1450)	40(5800)

**HYDRAULIC QUICK COUPLINGS STEEL**

Standard:ISO 7241-2  
 Part No.: KTM  
 Thead: NPT /BSP  
 Material: Carbon steel



PART NO.	THREAD		FLOW RATE	W.P.(Mpa/PSI)	B.P.(Mpa/PSI)
	BSP	NPT			
KTM-02	G1/4	Z1/4	18 (4.8)	35 (5000)	150(21800)
KTM-03	G3/8	Z3/8	30(7.9)	30 (4350)	150(21800)
KTM-04	G1/2	Z1/2	45 (12)	30 (4350)	160(23000)
KTM-06	G3/4	Z3/4	90 (24)	25 (3600)	120(17400)
KTM-08	G1	Z1	140 (37)	23 (3300)	100(145000)

**SUPER HIGH PRESSURE HYDRAULIC QUICK COUPLINGS**

Standard:ISO 7241-2  
 Part No.: KTC  
 Thead: NPT /BSP  
 Material: Carbon steel



PART NO.	THREAD		FLOW RATE	W.P.(Mpa/PSI)	B.P.(Mpa/PSI)
	BSP	NPT			
KTC-03	G3/8	Z3/8	23(6.0)	70 (10000)	150(21800)

**FLAT FACE HYDRAULIC QUICK COUPLINGS STEEL/STAINLESS STEEL**

Flat Face Hydraulic Quick Coupling  
 Standard:ISO 16028  
 Part No.: QKPT  
 Thead: NPT /BSP  
 Material: Carbon steel  
 Stainless Steel Coupling is QKPS



PART NO.	THREAD		FLOW RATE	W.P.(Mpa/PSI)	B.P.(Mpa/PSI)
	BSP	NPT			
QKPT-01	G1/8	Z1/8	12 (3.2)	35 (5000)	180(25700)
QKPT-02	G1/4	Z1/4	25 (6.6)	35 (5000)	180(25700)
QKPT-03	G3/8	Z3/8	50(13.2)	35 (5000)	170(24200)
QKPT-04	G1/2	Z1/2	110 (29)	35 (5000)	170(24200)
QKPT-05	G5/8	G5/8	125 (33)	35 (5000)	140(20000)
QKPT-06	G3/4	Z3/4	160 (42.4)	35 (5000)	140(20000)
QKPT-08	G1	Z1	230 (60.7)	35 (5000)	170(24200)

Hose  
 Ferrule  
 Fitting JIC  
 Fitting ORFS  
 Fitting NPT  
 Fitting SAE  
 Fitting BSP  
 Fitting Flange  
 Fitting Metric  
 Fitting JIS  
 Adapter  
 Quick Coupling  
 Camlock  
 Hose Clamp  
 Machine



Hose  
 Ferrule  
 Fitting JIC  
 Fitting ORFS  
 Fitting NPT  
 Fitting SAE  
 Fitting BSP  
 Fitting Flange  
 Fitting Metric  
 Fitting JIS  
 Adapter  
 Quick Coupling  
 Camlock  
 Hose Clamp  
 Machine

Size	Type	Body Material	Cam arm material	Gasket Material	Thread
1/2"-8"	A/B/C/D/D C/DP/E/F	Aluminum	Aluminum alloy	NBR(-30°C~100°C)	NPT/BSP
			Stainless steel	EPDM(-50°C~150°C)	
			Brass	Viton(-20°C~200°C)	

Size	1/2"	3/4"-2"	2-1/2"	3"	4"	5"-8"	6"
Working Pressure(PSI)	150	250	150	125	100	75	150



**Type A**  
Male Adapter&Female thread  
Aluminum SNP1/2"-8"

**Type B**  
Female Coupler&Male thread  
Aluminum SNP1/2"-8"

**Type C**  
Female Coupler&Hose Shank  
Aluminum SNP1/2"-8"



**Type D**  
Female Coupler&Female thread  
Aluminum SNP1/2"-8"

Hose & Coupler

**Type E**  
Male Adapter&Hose Shank  
Aluminum SNP1/2"-8"



**Type F**  
Male Adapter&Male Thread  
Aluminum SNP1/2"-8"

**Type DC**  
Dust Cap  
Aluminum SNP1/2"-8"

**Type DP**  
Dust Plug  
Aluminum SNP1/2"-8"

Size	Type	Body Material	Cam arm material	Gasket Material	Thread
1/2"-6"	A/B/C/D/DC/DP/E/F	SS316 or SS304	SS304	NBR(-30°C~100°C)	NPT/BSP
				EPDM(-50°C~150°C)	
				Viton(-20°C~200°C)	

Size	1/2"	3/4"-2"	2-1/2"	3"	4"-6"
W.P.	150PSI	250PSI	225PSI	200PSI	100PSI



**Type A**  
Male Adapter&Female thread  
SS316/304 SNP1/2"-8"

**Type B**  
Female Coupler&Male thread  
SS316/304 SNP1/2"-8"

**Type C**  
Female Coupler&Hose Shank  
SS316/304 SNP1/2"-8"



**Type D**  
Female Coupler&Female thread  
SS316/304 SNP1/2"-8"

Hose Couplings

**Type E**  
Male Adapter&Hose Shank  
SS316/304 SNP1/2"-8"



**Type F**  
Male Adapter&Male Thread  
SS316/304 SNP1/2"-8"

**Type DC**  
Dust Cap  
SS316/304 SNP1/2"-8"

**Type DP**  
Dust Plug  
SS316/304 SNP1/2"-8"

Hose  
 Ferrule  
 Fitting JIC  
 Fitting ORFS  
 Fitting NPT  
 Fitting SAE  
 Fitting BSP  
 Fitting Flange  
 Fitting Metric  
 Fitting JIS  
 Adapter  
 Quick Coupling  
 Camlock  
 Hose Clamp  
 Machine



Hose  
 Ferrule  
 Fitting JIC  
 Fitting ORFS  
 Fitting NPT  
 Fitting SAE  
 Fitting BSP  
 Fitting Flange  
 Fitting Metric  
 Fitting JIS  
 Adapter  
 Quick Coupling  
 Camlock  
 Hose Clamp  
 Machine

Size	Type	Body Material	Cam arm material	Gasket Material	Thread
1/2"-4"	A/B/C/D/DC/DP/E/F	Polypropylene and nylon	Stainless Steel or PP	NBR/EPDM	NPT/BSP



**Type A**  
 Male Adapter & Female thread  
 PP SNP1/2"-4"



**Type B**  
 Female Coupler & Male thread  
 PP SNP1/2"-4"



**Type C**  
 Female Coupler & Hose Shank  
 PP SNP1/2"-4"



**Type D**  
 Female Coupler & Female thread  
 PP SNP1/2"-4"



HOSE COUPLINGS NYLON



**Type E**  
 Male Adapter & Hose Shank  
 PP SNP1/2"-4"



**Type F**  
 Male Adapter & Male Thread  
 PP SNP1/2"-4"



**Type DC**  
 Dust Cap  
 PP SNP1/2"-4"



**Type DP**  
 Dust Plug  
 PP SNP1/2"-4"



AR A TYPE REDUCING MALE ADAPTER \* FEMALE THREAD



AA SPOOL ADAPTER MALE ADAPTER \* MALE ADAPTER



BR B TYPE REDUCING FEMALE COUPLER \* MALE THREAD

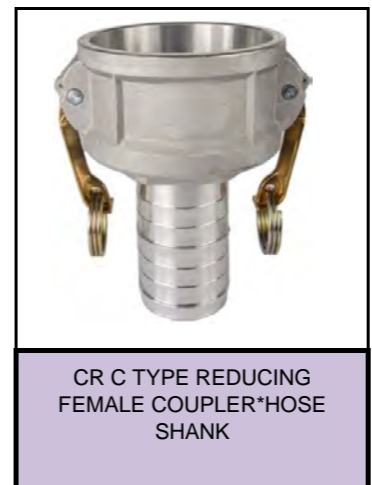

CR C TYPE REDUCING FEMALE COUPLER \* HOSE SHANK



DA D&A TYPE REDUCING FEMALE COUPLING \* MALE ADAPTER



DCL LOCKABLE DUST CAP WITH \* L TYPE HANDLE



DD SPOOL COUPLER FEMALE COUPLER \* FEMALE COUPLER

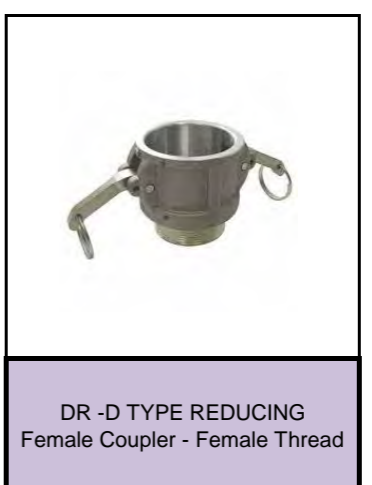

DR -D TYPE REDUCING Female Coupler - Female Thread



ER E TYPE REDUCING MALE ADAPTER \* HOSE SHANK



FR F TYPE REDUCING MALE ADAPTER \* MALE THREAD



FA & FC CAM & GROOVE FLANGE COUPLING

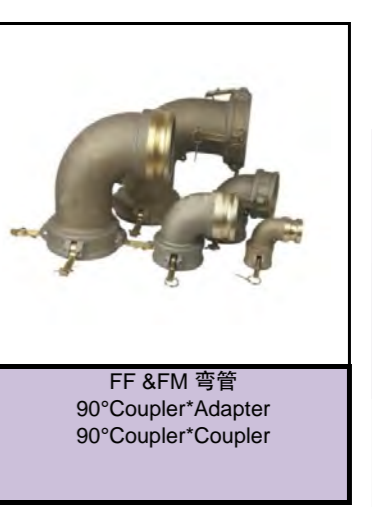

FF & FM 弯管 90° Coupler \* Adapter 90° Coupler \* Coupler

Hose  
 Ferrule  
 Fitting JIC  
 Fitting ORFS  
 Fitting NPT  
 Fitting SAE  
 Fitting BSP  
 Fitting Flange  
 Fitting Metric  
 Fitting JIS  
 Adapter  
 Quick Coupling  
 Camlock  
 Hose Clamp  
 Machine



Hose							Hose
Ferrule							Ferrule
Fitting JIC	螺旋式C型 SPIRAL SHANK COUPLING - C TYPE 4"	C型法式管尾 SPIRAL SHANK COUPLING - C TYPE *HELICAL 4"	螺旋式C型长管 SPIRAL SHANK COUPLING - C TYPE WITH COLLAR	68° C型弯管 60° Coupler * Hose Shank 2" 3"	90°C型 90° Coupler* Hose Shank 2" 3"	90°弯头 90° BEND 2"/3"/4"	Fitting JIC
Fitting ORFS							Fitting ORFS
Fitting NPT							Fitting NPT
Fitting SAE							Fitting SAE
Fitting BSP	管尾 HOSE SHANK (W/W.O COLLAR)- AL	螺旋管尾 HELICAL HOSE SHANK -AL	螺旋管尾带铝套 HELICAL HOSE SHANK WITH FEUULE-AL	TANKER FITTINGS 罐车接头 TIGHT FILL ELBOW 4"	API 连接器 API COUPLER*ADAPTER WITH CHAIN 2-1/2"/3"/4"	API 盖子 API CAPS WITH CHAIN 4"	Fitting BSP
Fitting Flange							Fitting Flange
Fitting Metric							Fitting Metric
Fitting JIS							Fitting JIS
Adapter	外牙螺旋管尾 MALE HELICAL HOSE SHANK -AL	内牙不带锁 FEMALE W/O LATCH-AL	内牙带锁 FEMALE WITH LATCH-AL	API 法式连接器 API COUPLER *GUILLEMIN COUPLING 3"	C 型阀双螺纹管尾 C TYPE VALVE + SPIRAL HOSE SHANK 4"	螺旋沟槽式C型 SPIRAL SHANK COUPLING -C TYPE WITH GROOVE 2"/2-1/2"/3"/4"	Adapter
Quick Coupling							Quick Coupling
Camlock							Camlock
Hose Clamp	外牙不带锁 MALE W/O LATCH-AL	外牙带锁 MALE WITH LATCH	盖子 CAP WITH CHAIN -AL	68°螺旋沟槽式C型 SPIRAL SHANK COUPLING - 68° C TYPE WITH GROOVE 2"/2-1/2"/3"/4"	KC NIPPLE	HOSE MENDER	Hose Clamp
Machine							Machine

Hose

Ferrule

Fitting JIC

Fitting ORFS

Fitting NPT

Fitting SAE

Fitting BSP

Fitting Flange

Fitting Metric

Fitting JIS

Adapter

Quick Coupling

Camlock

Hose Clamp

Machine



堵头  
CHOKE PLUG WITH CHAIN-AL



HELICA HOSE SHANK  
Stainless Steel



FEMALE WITH LATCH  
Stainless Steel



CAP WITH CHAIN  
Stainless Steel



异径接头  
REDUCING COUPLING-AL



MALE HELICAL HOSE SHANK  
Stainless Steel



MALE W/O LATCH  
Stainless Steel



REDUCING COUPLING  
Stainless Steel



HOSE SHANK (W/W.O COLLAR)  
Stainless Steel



FEMALE W/O LATCH  
Stainless Steel



MALE WITH LATCH  
Stainless Steel



STANDARD PIN LUG COUPLING

Hose

Ferrule

Fitting JIC

Fitting ORFS

Fitting NPT

Fitting SAE

Fitting BSP

Fitting Flange

Fitting Metric

Fitting JIS

Adapter

Quick Coupling

Camlock

Hose Clamp

Machine



EUROPEAN TYPE  
WITH COLLAR管子带扣



EUROPEAN TYPE  
W/O COLLAR



AMERICA TYPE  
MALE END 外牙



AMERICA TYPE  
FOURLUG-MALE END 外牙



EUROPEAN TYPE  
MALE END 外牙



AMERICA TYPE  
HOSE END 管子



AMERICA TYPE  
FOURLUG-HOSE END 四爪管子



AMERICA TYPE  
3WAY CONNECTOR 美式三通



EUROPEAN TYPE  
FEMALE END 内牙



AMERICA TYPE  
FEMALE END 内牙



AMERICA TYPE  
FOURLUG-FEMALE END 四爪内牙



AMERICA TYPE  
BLANKEND US TYPE美式堵头



Hose  
 Ferrule  
 Fitting JIC  
 Fitting ORFS  
 Fitting NPT  
 Fitting SAE  
 Fitting BSP  
 Fitting Flange  
 Fitting Metric  
 Fitting JIS  
 Adapter  
 Quick Coupling  
 Camlock  
 Hose Clamp  
 Machine

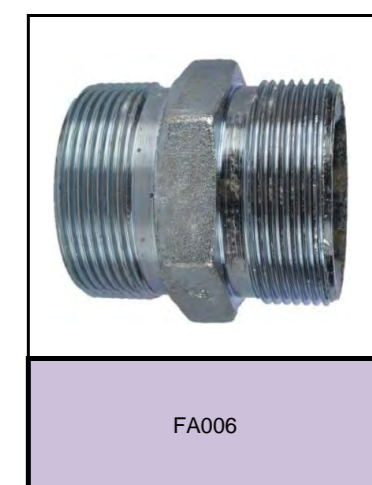
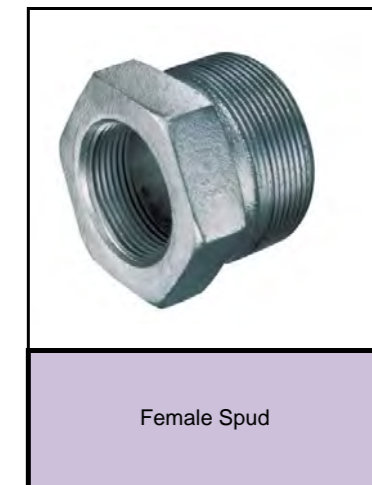
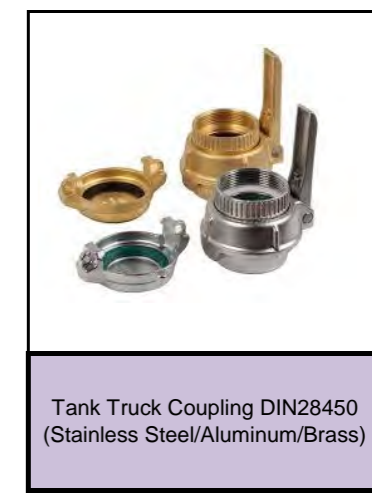
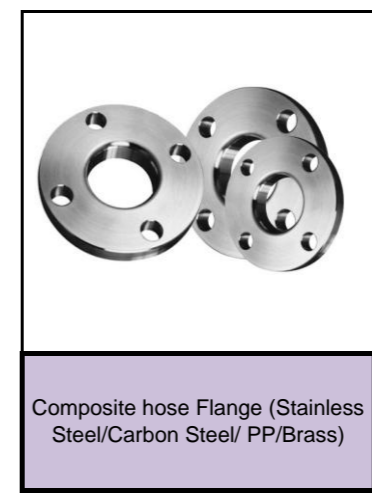
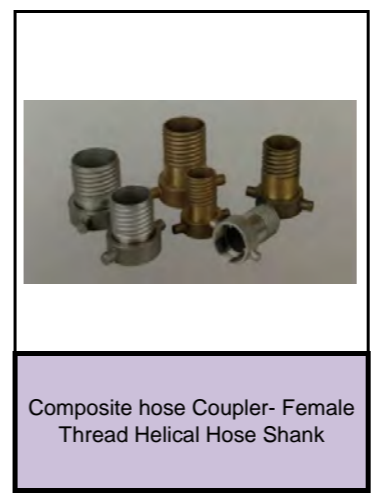
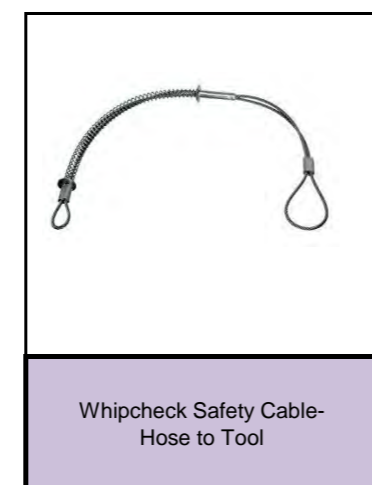
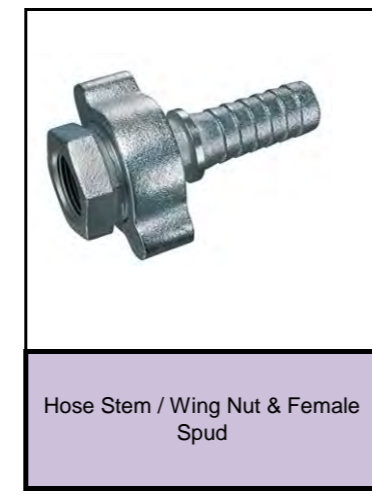
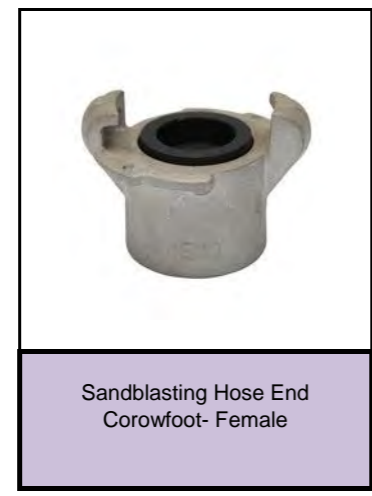
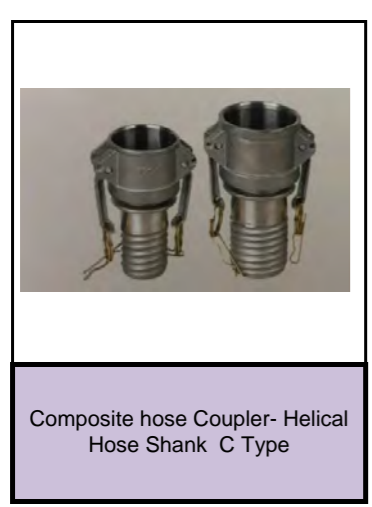
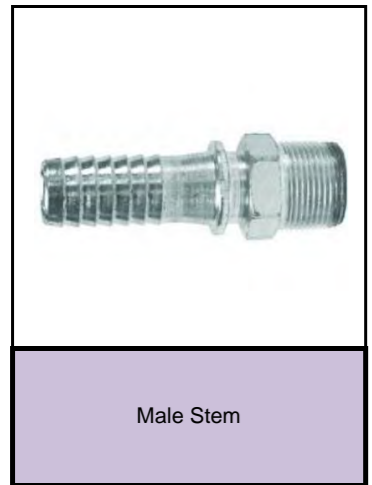

Hose  
 Ferrule  
 Fitting JIC  
 Fitting ORFS  
 Fitting NPT  
 Fitting SAE  
 Fitting BSP  
 Fitting Flange  
 Fitting Metric  
 Fitting JIS  
 Adapter  
 Quick Coupling  
 Camlock  
 Hose Clamp  
 Machine

Hose  
 Ferrule  
 Fitting JIC  
 Fitting ORFS  
 Fitting NPT  
 Fitting SAE  
 Fitting BSP  
 Fitting Flange  
 Fitting Metric  
 Fitting JIS  
 Adapter  
 Quick Coupling  
 Camlock  
 Hose Clamp  
 Machine



**Germany Hose Clamp 9mm**  
 Material:  
 W1: Galvanized Steel  
 W2: Screw is Steel, Band and housing SS200 /SS300  
 W4: Whole body Stainless steel  
 Size 8-180



**Double ear hose clamp**  
 Material:  
 Whole body galvanized steel  
 Bandwidth 7/9/10mm



**Robust Clamp with solid trunnion**  
 Material:  
 W1: Galvanized Steel  
 W2: The bolt and trunnion galvanized steel, others Stainless steel  
 W4: Whole body SS200/SS300  
 W5: All the parts are SS316  
 Clamping range: 1252



**Germany Hose Clamp 12mm**  
 Material:  
 W1: Galvanized Steel  
 W2: Screw is Steel, Band and housing SS200 /SS300  
 W4: Whole body Stainless steel  
 Size 12-180



**TWO OR FOUR BOLT CLAMP**



**Double Wire hose clamp**  
 Material:  
 W2: Bolt is Steel, Band and housing SS200 /SS300  
 W4: Whole body Stainless steel  
 Size: 11-120  
 Wire :1.5/ 1.8/2.2/2.5 mm



**American Hose Clamp 12.7mm**  
 Material:  
 W1: Galvanized Steel  
 W2: Screw is Steel, Band and housing SS200 /SS300  
 W4: Whole body Stainless steel  
 Size 10-305



**SK HOSE CLAMP**



**SL HOSE CLAMP**

**SNP-32B Crimping Machine**  
 Swaging range 1/8" -2" 4SP  
 Max swaging force 5260KN  
 Voltage & motor 220V/2.2KW or 380V/4KW  
 No. of standard die set 13 sets  
 Outline diameter 800\*650\*1320mm  
 Weight 320KG



**SNP-32D Crimping Machine**  
 Swaging range 1/8" -2" 6S  
 Max swaging force 5260KN  
 Voltage & motor 220V/2.2KW or 380V/4KW  
 No. of standard die set 13 sets  
 Outline diameter 650\*650\*1300mm  
 Weight 350KG



**DSG-250A/B/C-Crimping Machine**  
 Crimping Range: 1/4" -2"  
 Power: 4KW(Oil Motor)  
 Max crimping force: 407Tons/640Tons  
 Outline dimension: 850X450X1300mm  
 Mould: Ø16 Ø19 Ø23 Ø26 Ø30 Ø34 Ø38 Ø45 Ø52 Ø63



**SNP-DX68 Crimping Machine**  
 Swaging range 1/8" -2" 4S  
 Max swaging force 400T  
 Voltage & motor 220V/2.2KW or 380V/3KW  
 No. of standard die set 10 sets  
 Outline diameter 670\*430\*950mm  
 Weight 260KG



**SNP-60A Crimping Machine**  
 Swaging range 1/8" -4" 4SP  
 Max swaging force 12560KN  
 Voltage & motor 220V/2.2KW or 380V/5.5KW  
 No. of standard die set 13 sets  
 Outline diameter 1100\*700\*1200mm  
 Weight 980KG



Hose  
 Ferrule  
 Fitting JIC  
 Fitting ORFS  
 Fitting NPT  
 Fitting SAE  
 Fitting BSP  
 Fitting Flange  
 Fitting Metric  
 Fitting JIS  
 Adapter  
 Quick Coupling  
 Camlock  
 Hose Clamp  
 Machine



- Hose
- Ferrule
- Fitting JIC
- Fitting ORFS
- Fitting NPT
- Fitting SAE
- Fitting BSP
- Fitting Flange
- Fitting Metric
- Fitting JIS
- Adapter
- Quick Coupling
- Camlock
- Hose Clamp
- Machine

**Manual Hose Crimping Machine JKS200**  
 Crimping Range:  $\Phi 6$ - $\Phi 32$   
 Weight: 100Kg  
 Outline dimension: 600X350X460mm



**SNP-C20 Cutting Machine**  
 Swaging range 1/8" -2" 6S  
 Voltage & motor 220V/2.2KW or 380V/5.5KW  
 Outline diameter 810\*610\*1150mm  
 Weight 180KG



**SNP-C10 Cutting Machine**  
 Cutting tube: 4wire 2",2wire 4"  
 Power:3Kw  
 Measurement: 730X650X1000mm  
 Weight: 120Kg



**SNP-C05**  
 Cutting tube:  $\Phi 38$   
 Power: 3Kw  
 Measurement: 640X460X490mm  
 Weight: 70Kg



**The Peeling Machine HYBJ**  
 Peeling range:  $\Phi 6$ - $\Phi 51$ mm  
 Power: 1.1Kw  
 Measurement: 710X480X1010mm  
 Weight: 80Kg  
 With Peeling mandrel 11 piece

